



CITY

60034



 LEGO.com/city



WARNING: CHOKING HAZARD.
Toy contains small parts and a small ball.
Not for children under 3 years.

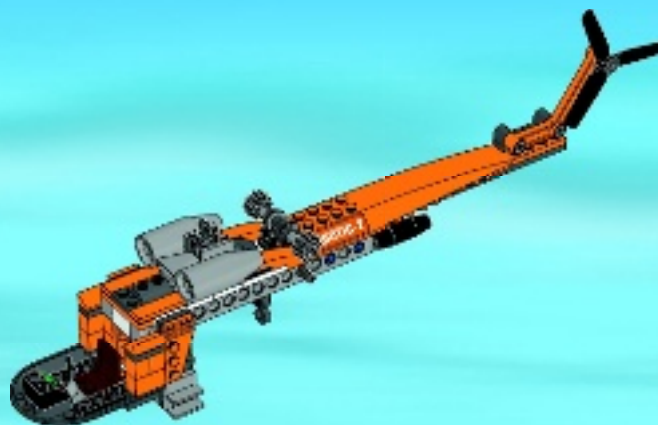

AVERTISSEMENT : RISQUE D'ÉTOUFFEMENT.
Le jouet contient des petites pièces ainsi qu'une petite boule.
Il ne convient pas aux enfants de moins de 3 ans.



ADVERTENCIA: PELIGRO DE ASFIXIA.
Juguete que contiene partes pequeñas y una pelota pequeña.
No recomendado para niños menores de 3 años.



FSC
www.fsc.org

MIX

Paper from
responsible sources

FSC® C117818

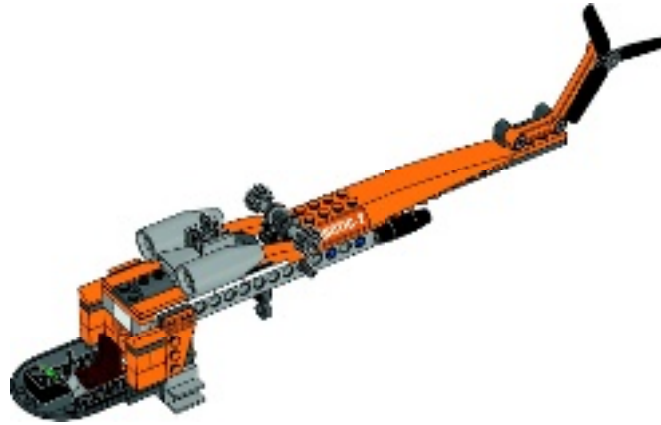

1x

1

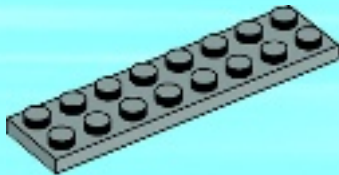

2x

2

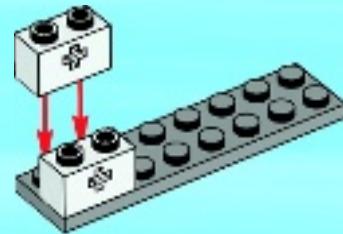



1x

3

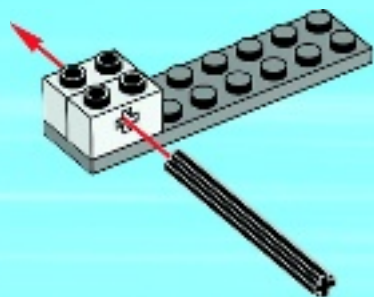

2x

4

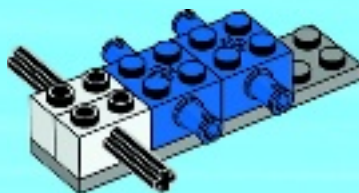

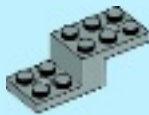

1x

5

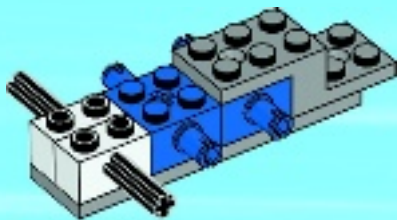

1x



2x

6

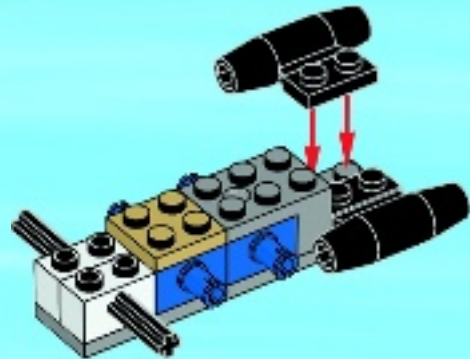

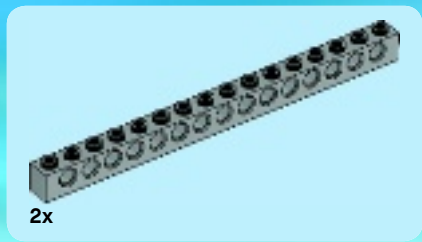

7

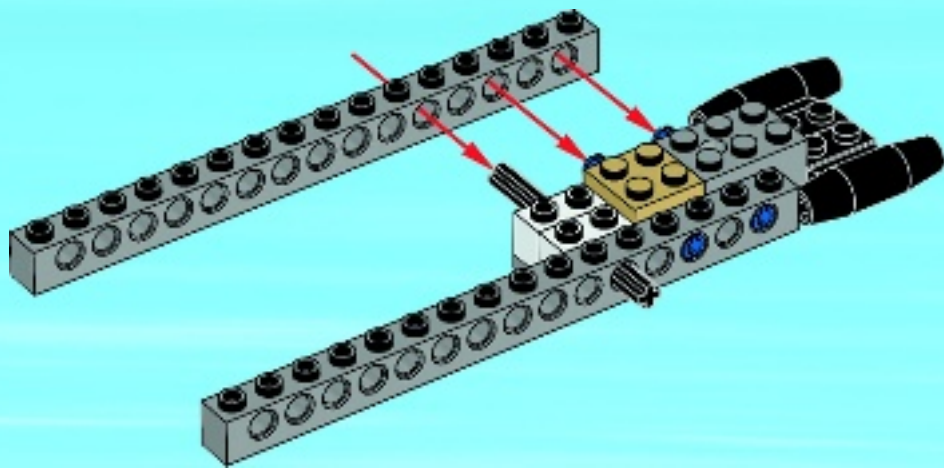



1x

8

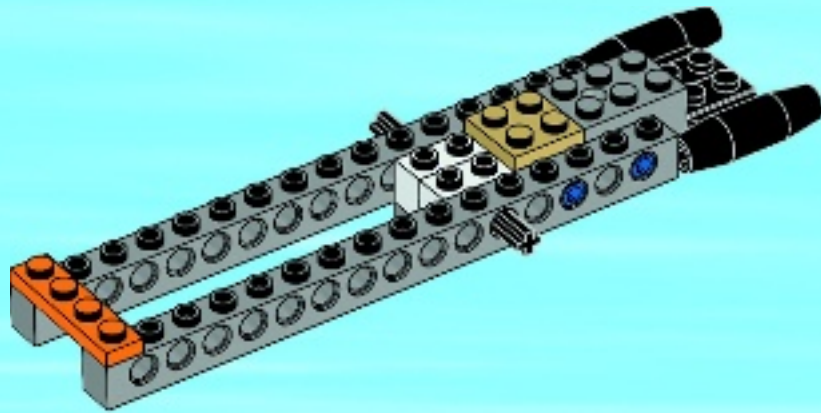



2x

9

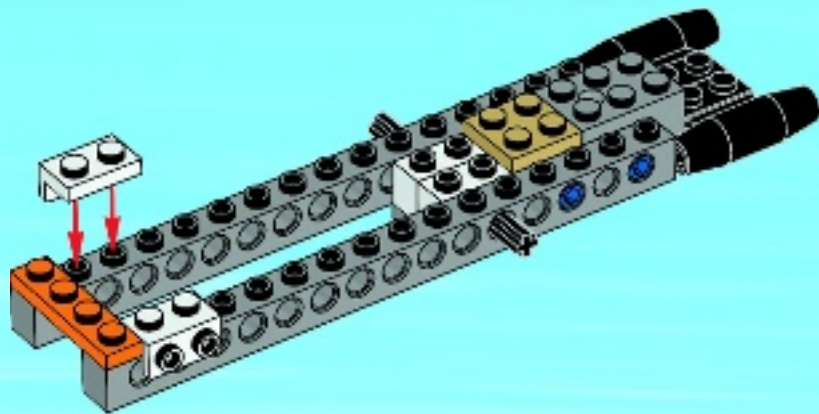



1x

10

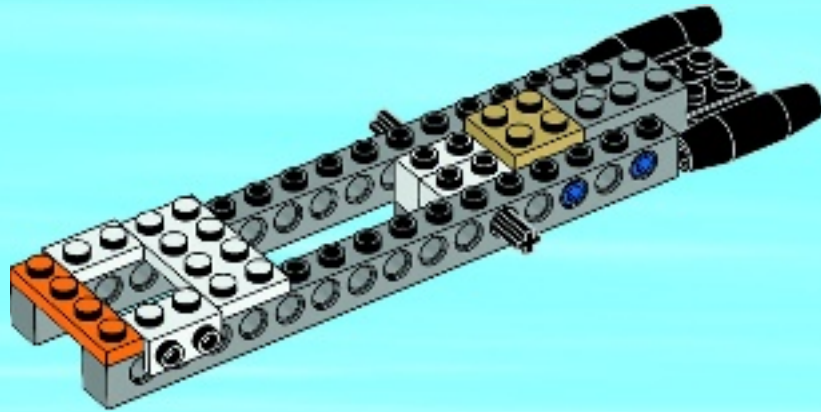



2x

11

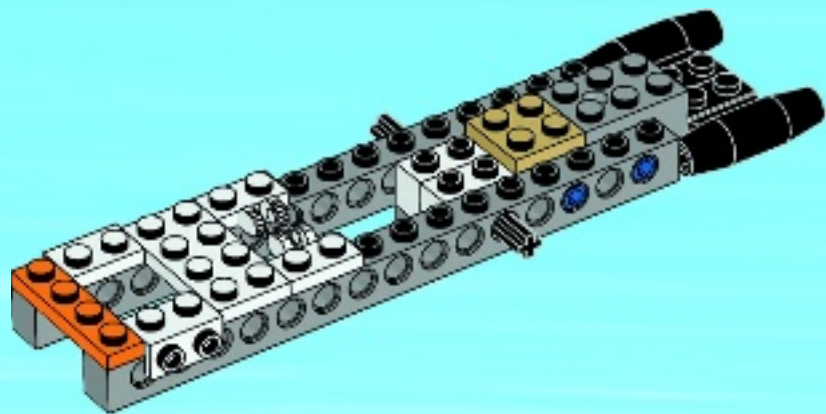



2x

12

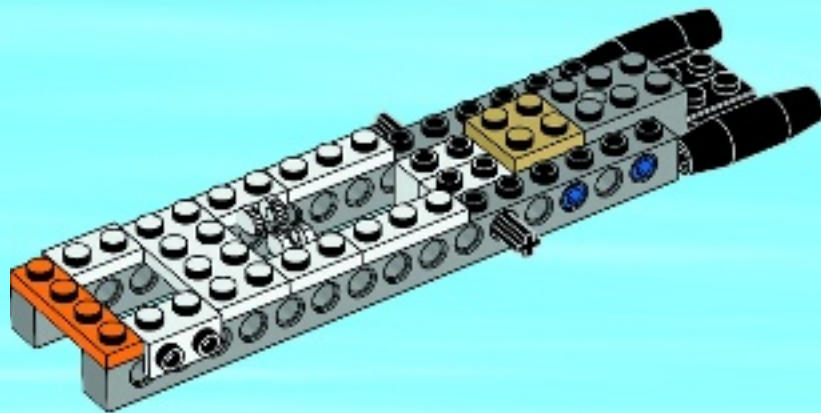



2x

13

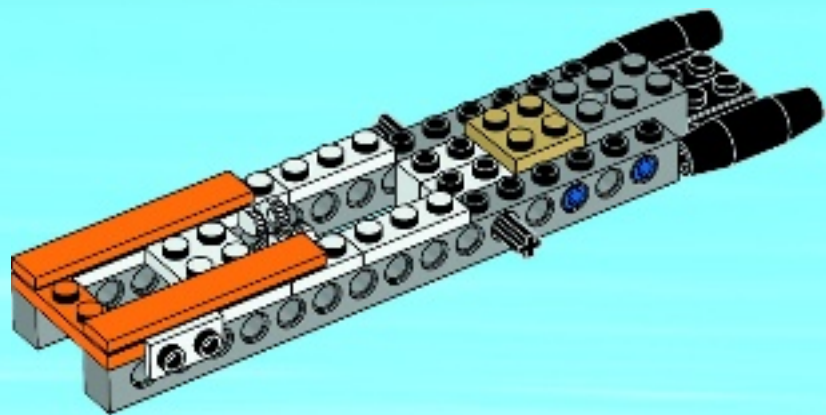



1x



1x

14

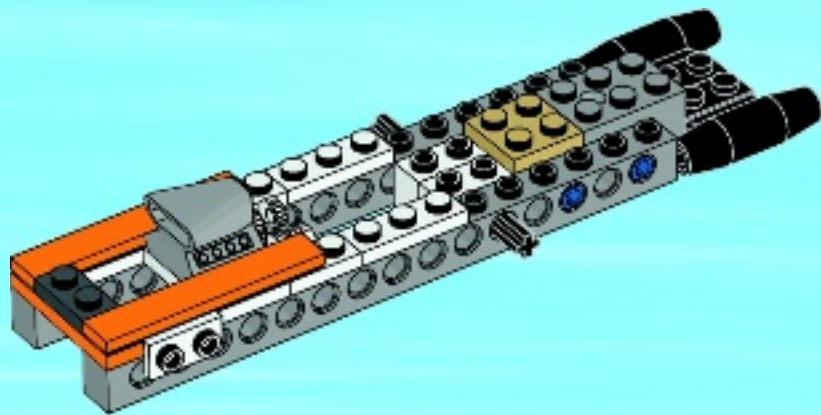



1x

15

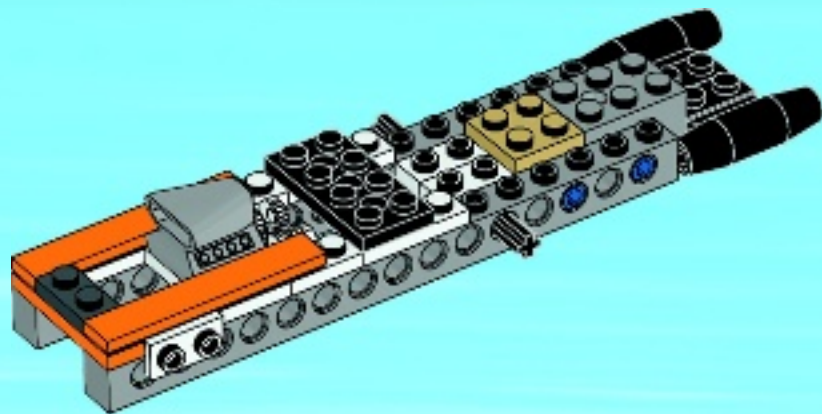



2x

16

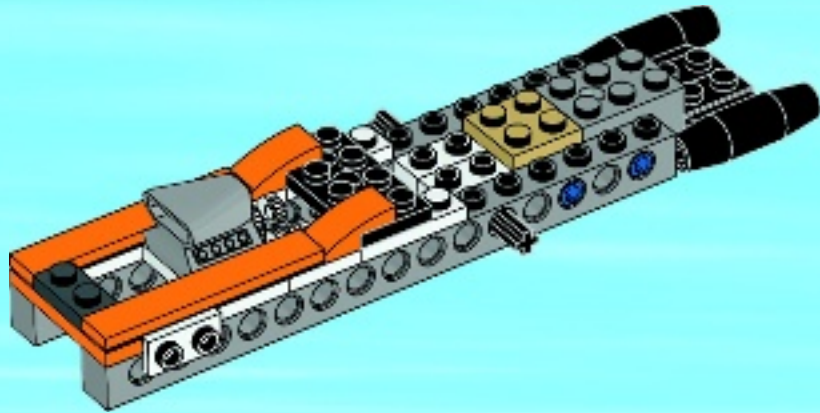



2x

17

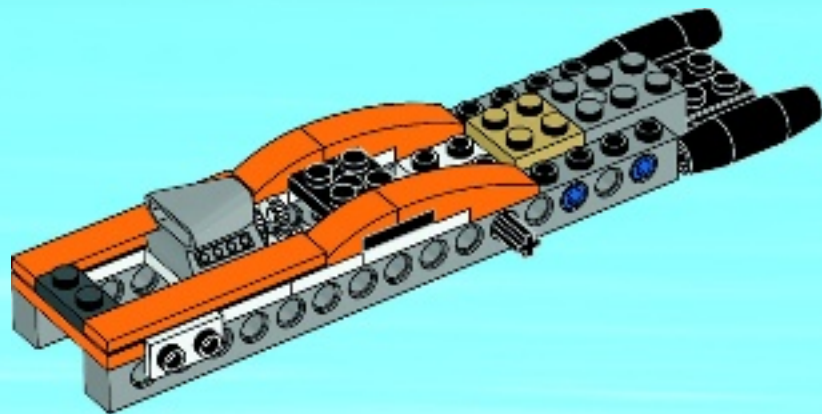



1x



1x

18

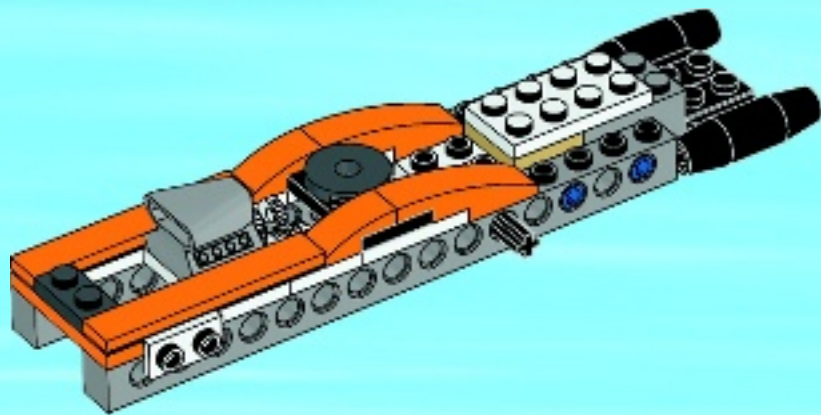

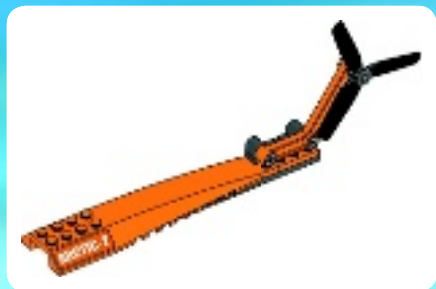

1x

1

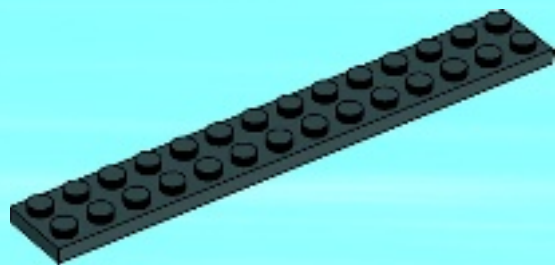

2x

2

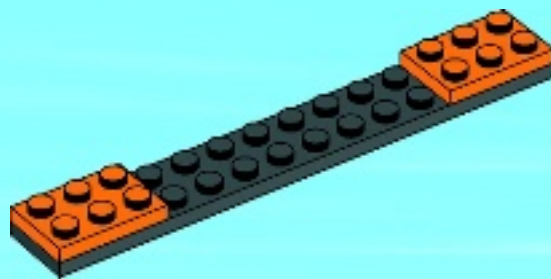

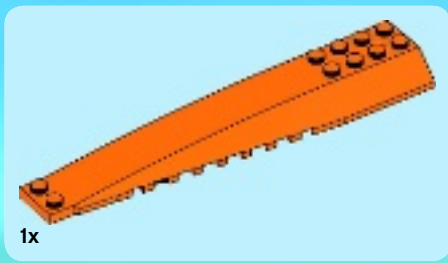

3

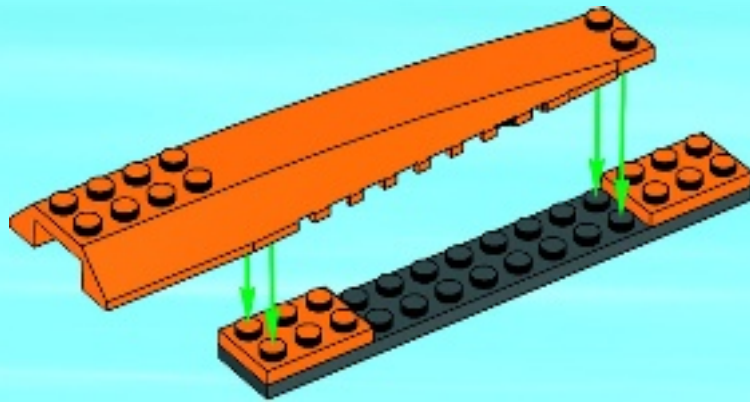

4

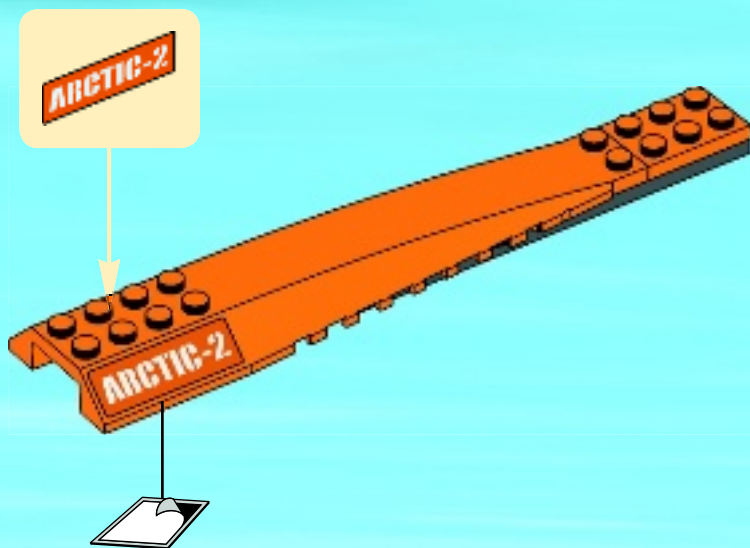



2x

5

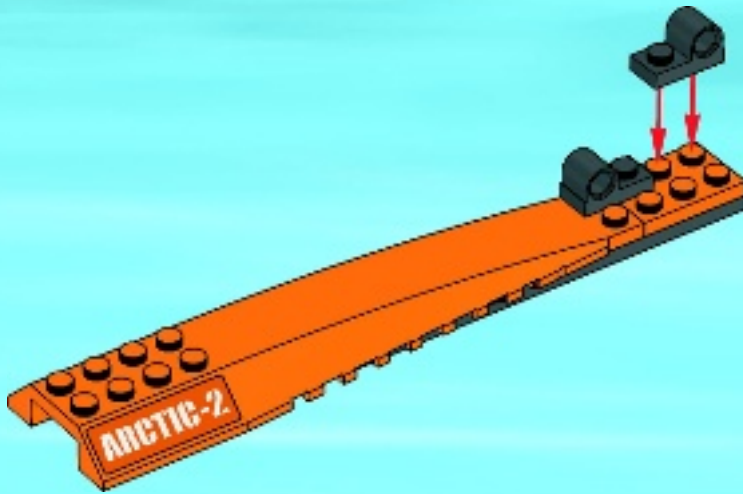



2x

6

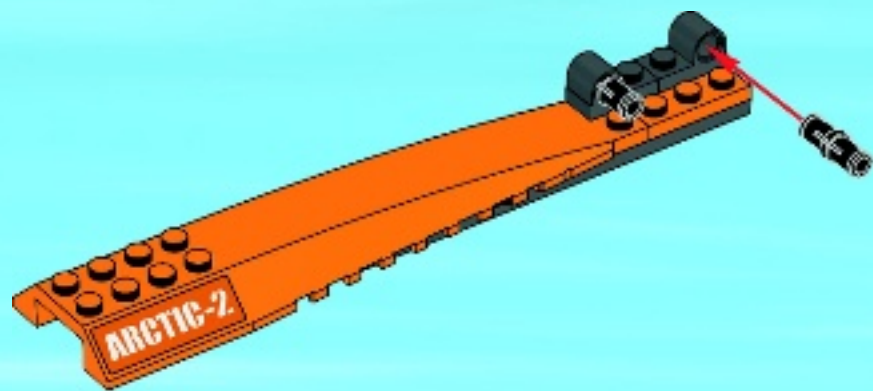

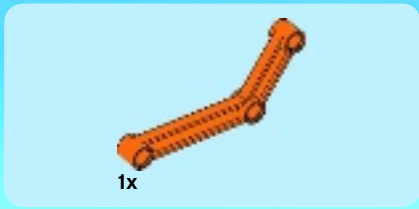

7

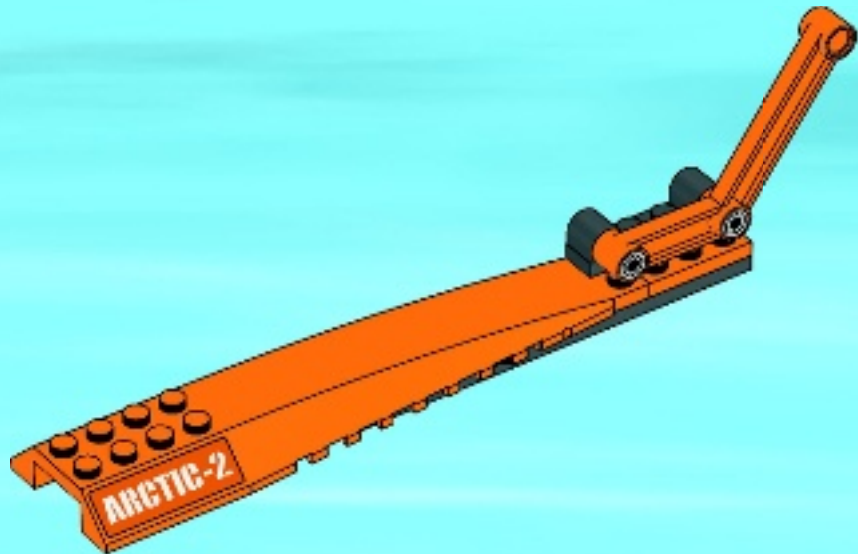

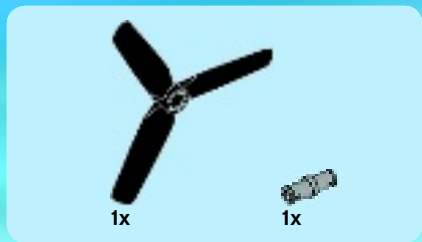

8

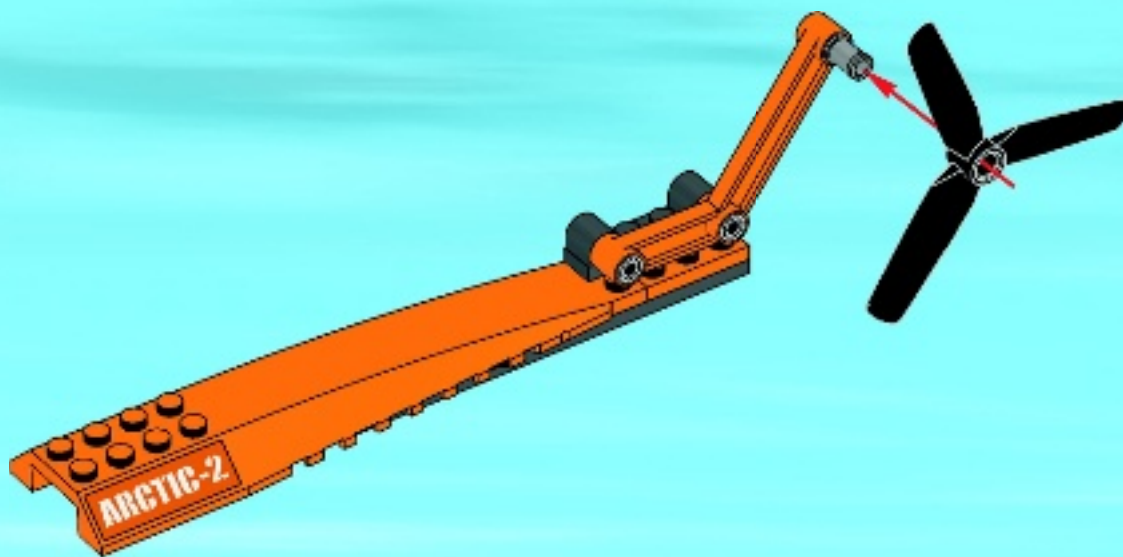

19

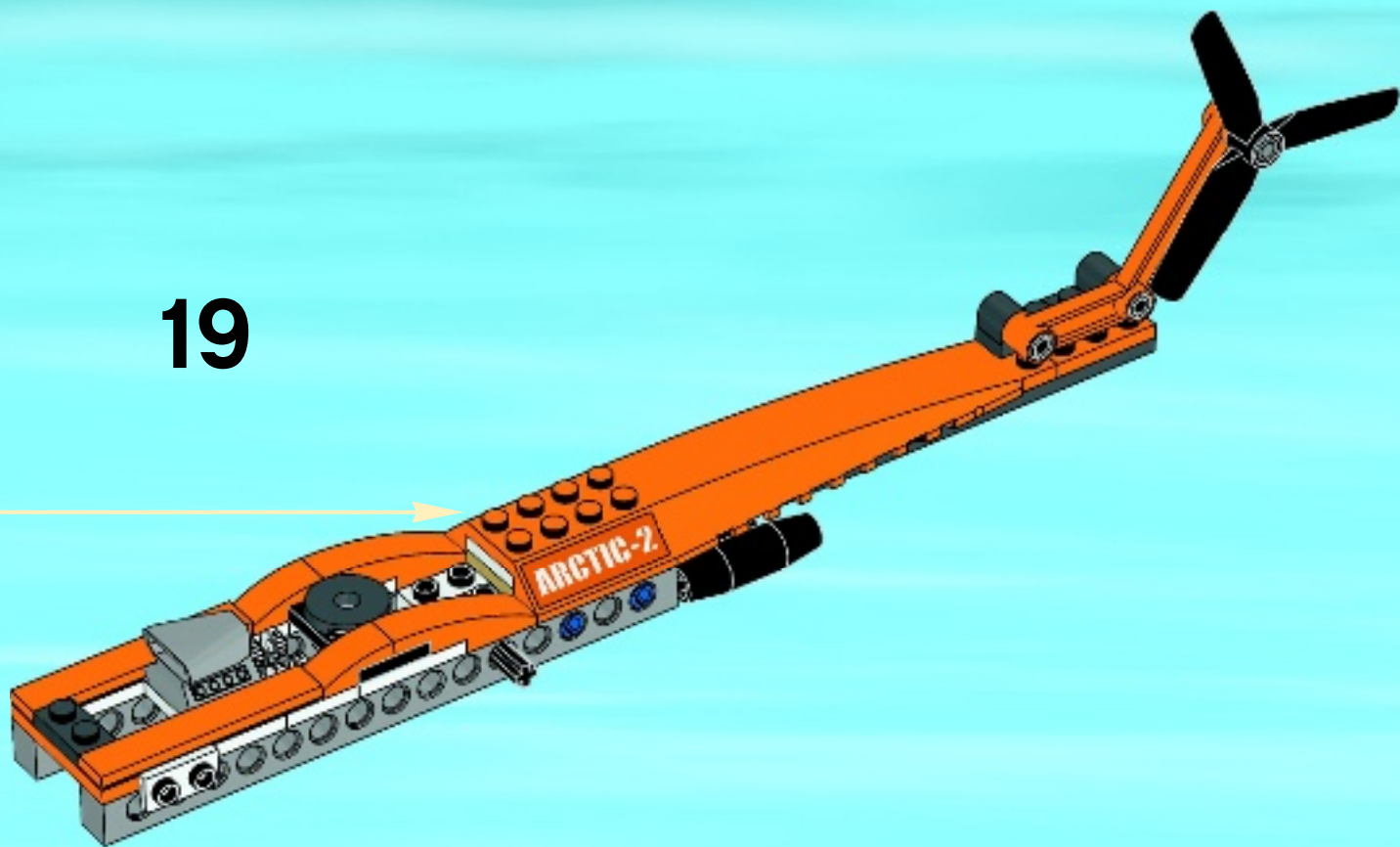

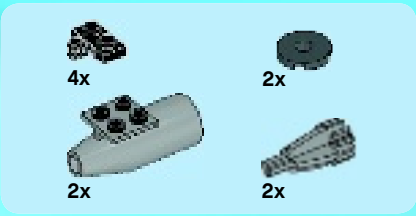

20

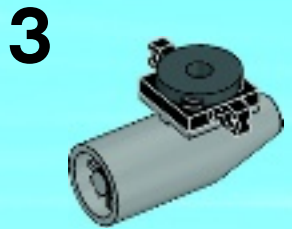
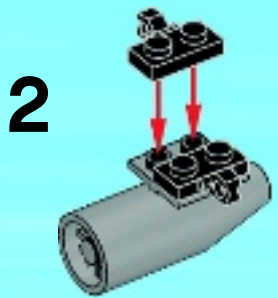
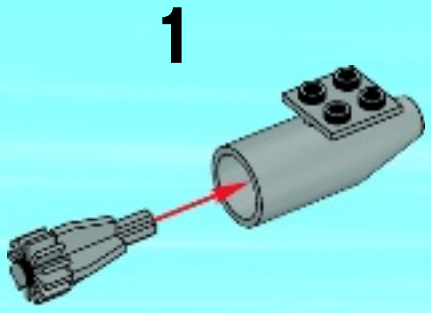

2x

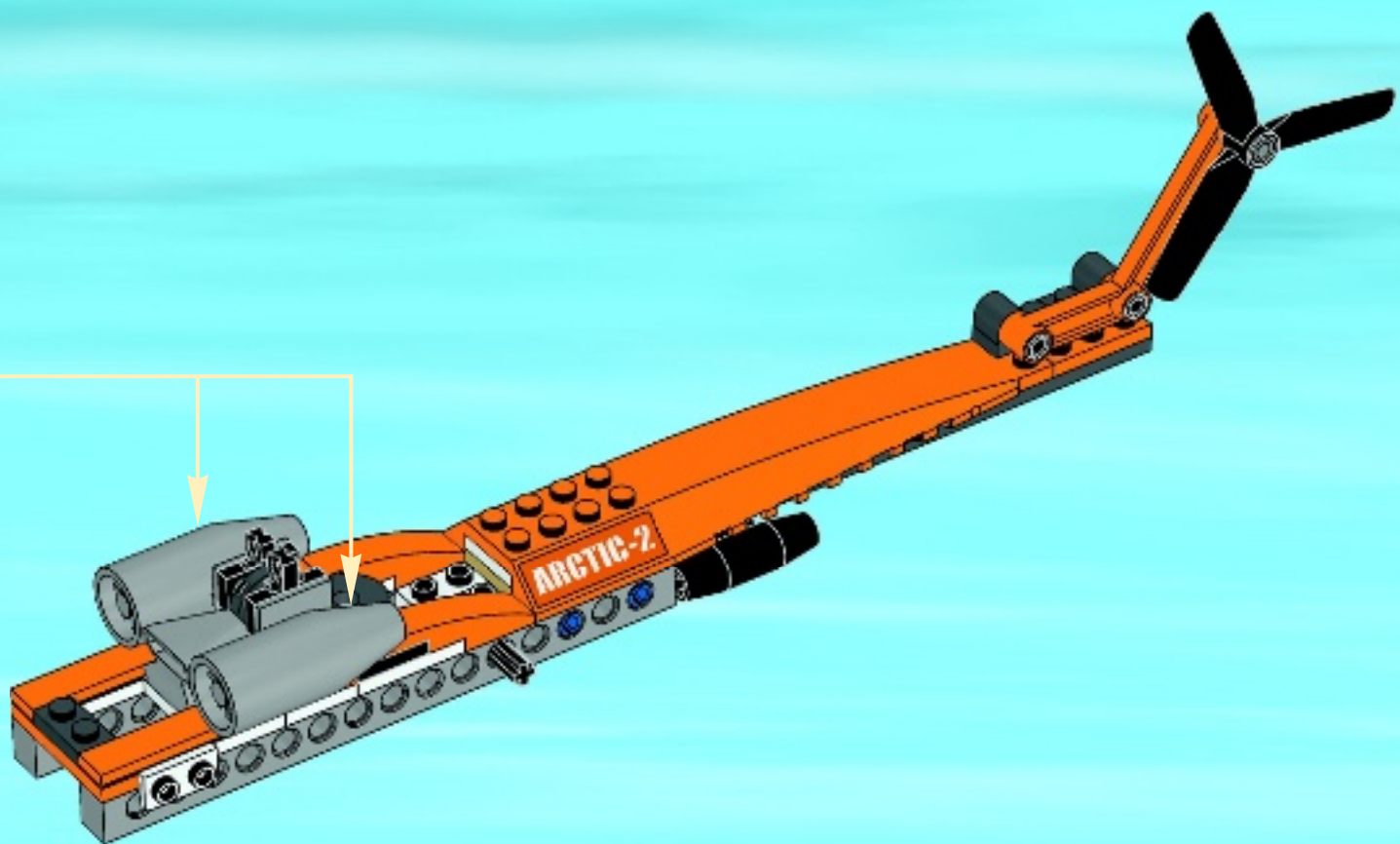

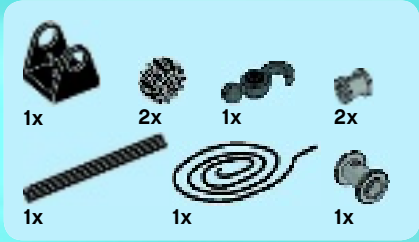

21

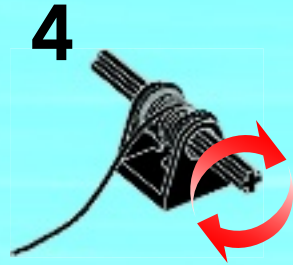
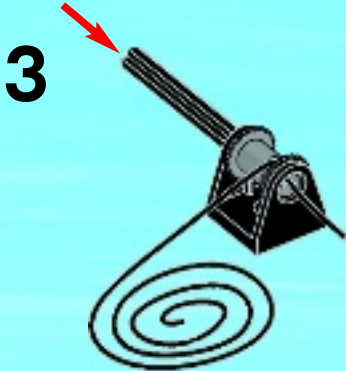

5



6



7

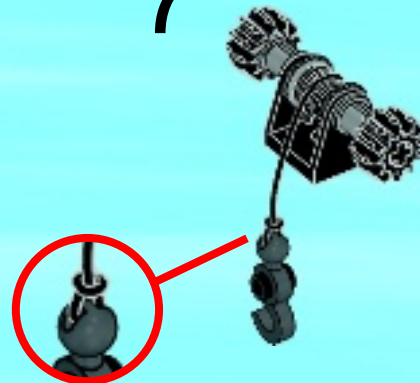

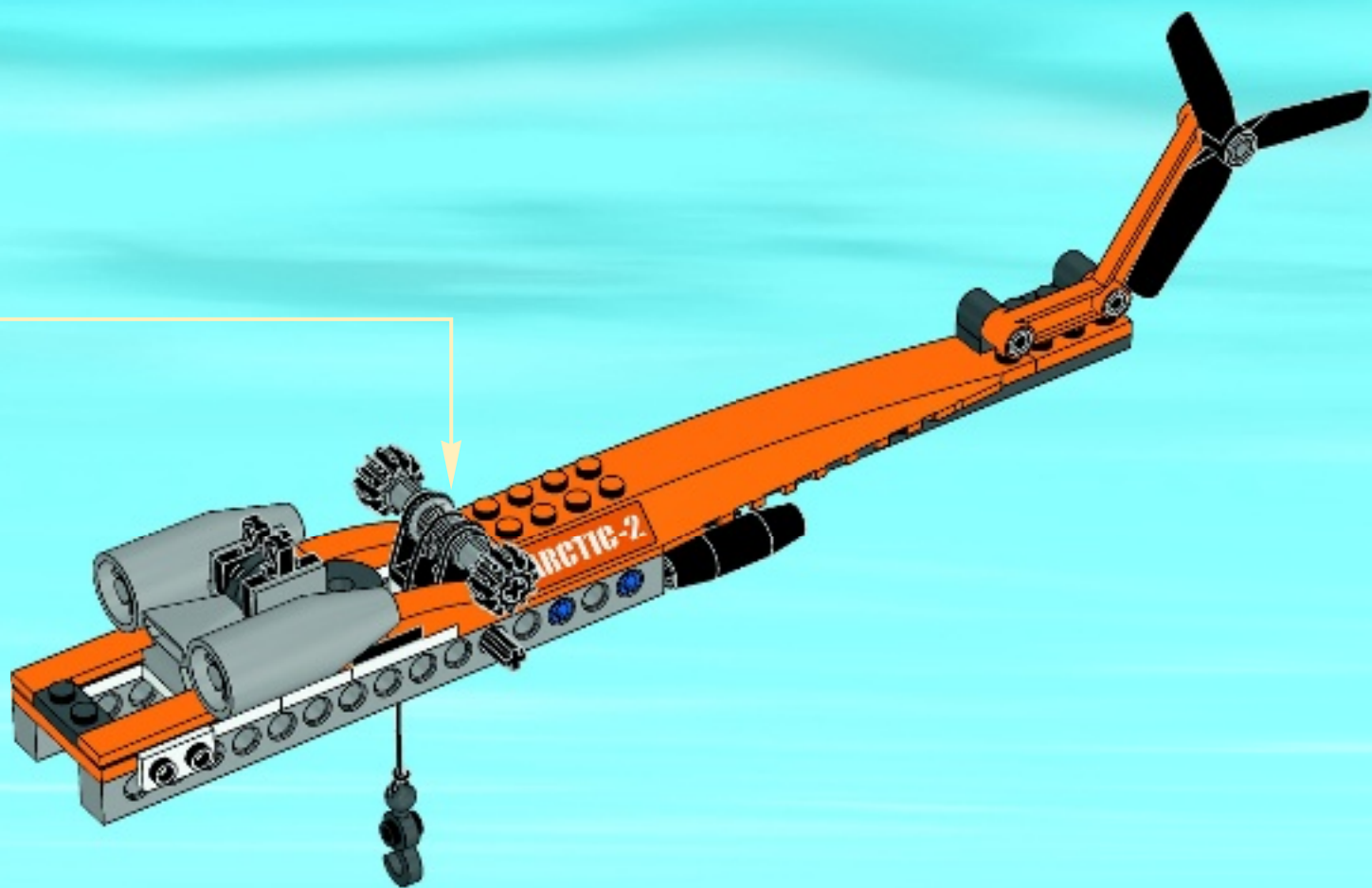



1x

1



1x

2





2x



2x

3

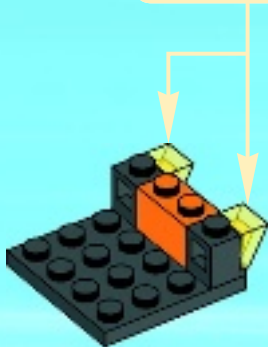
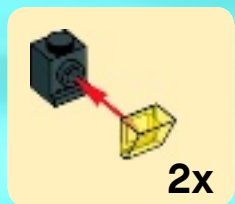

1x

4





1x

5

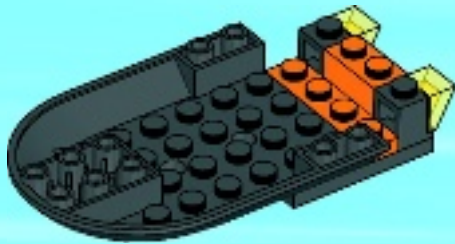

2x

6





1x



1x

7

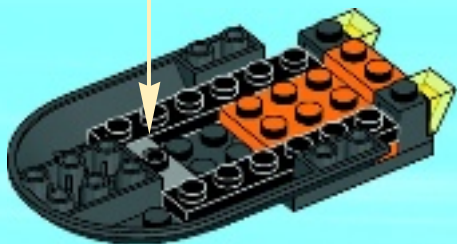

1x

8





1x



1x

9



1x

10

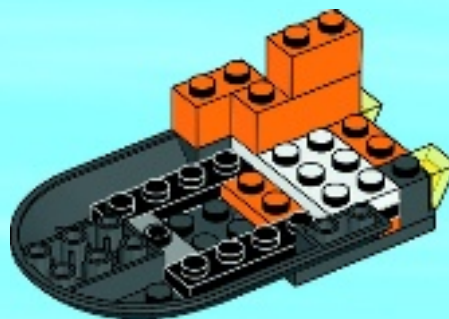



1x



1x

11

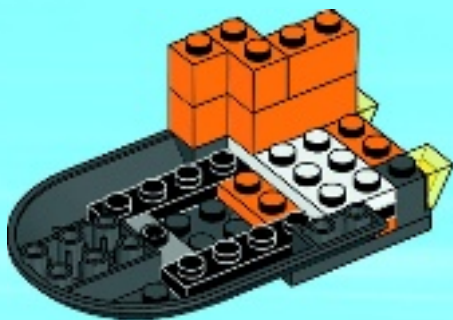

1x



1x

12

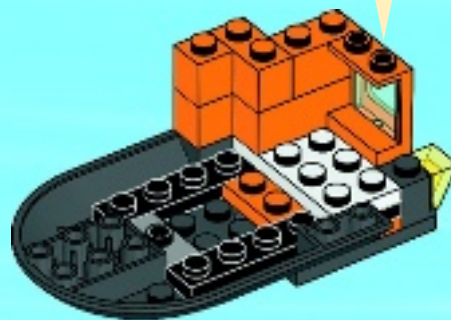
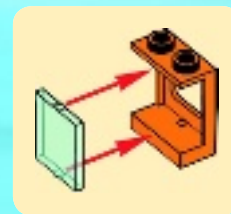



2x

13



1x



1x

14

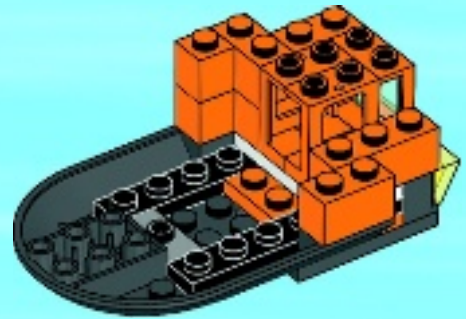



1x

15

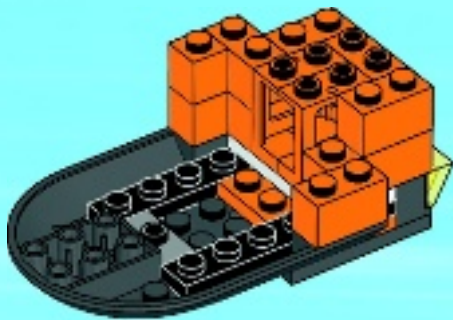

1x



1x

16

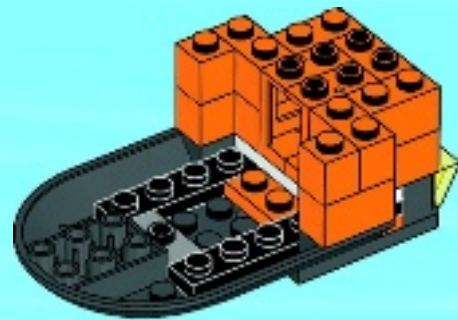



1x



1x

17

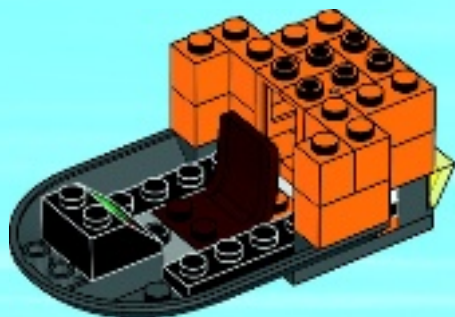

2x

18

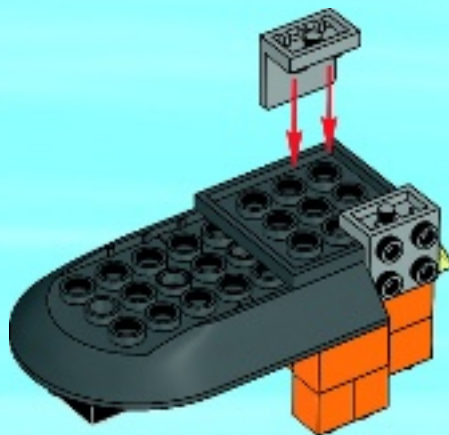



1x

19

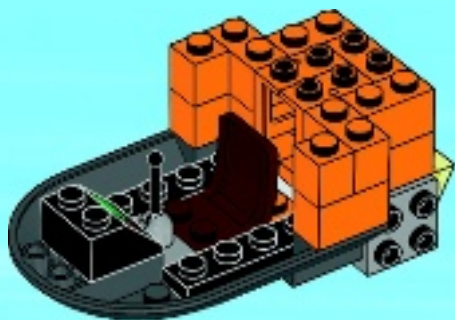



1x



2x

20

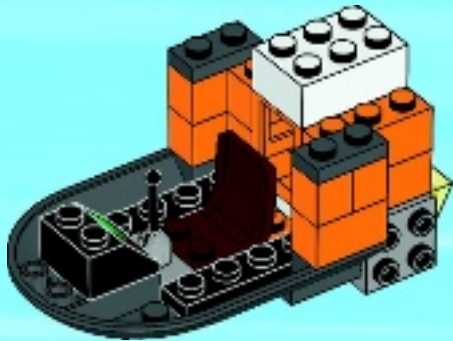

1x



2x

21

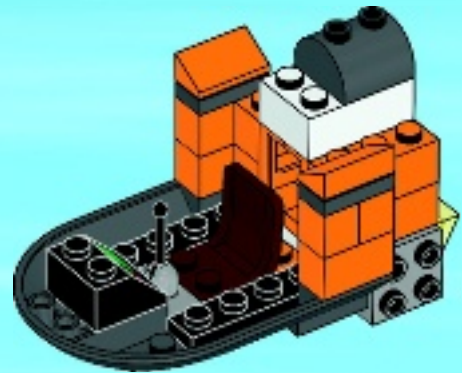

22

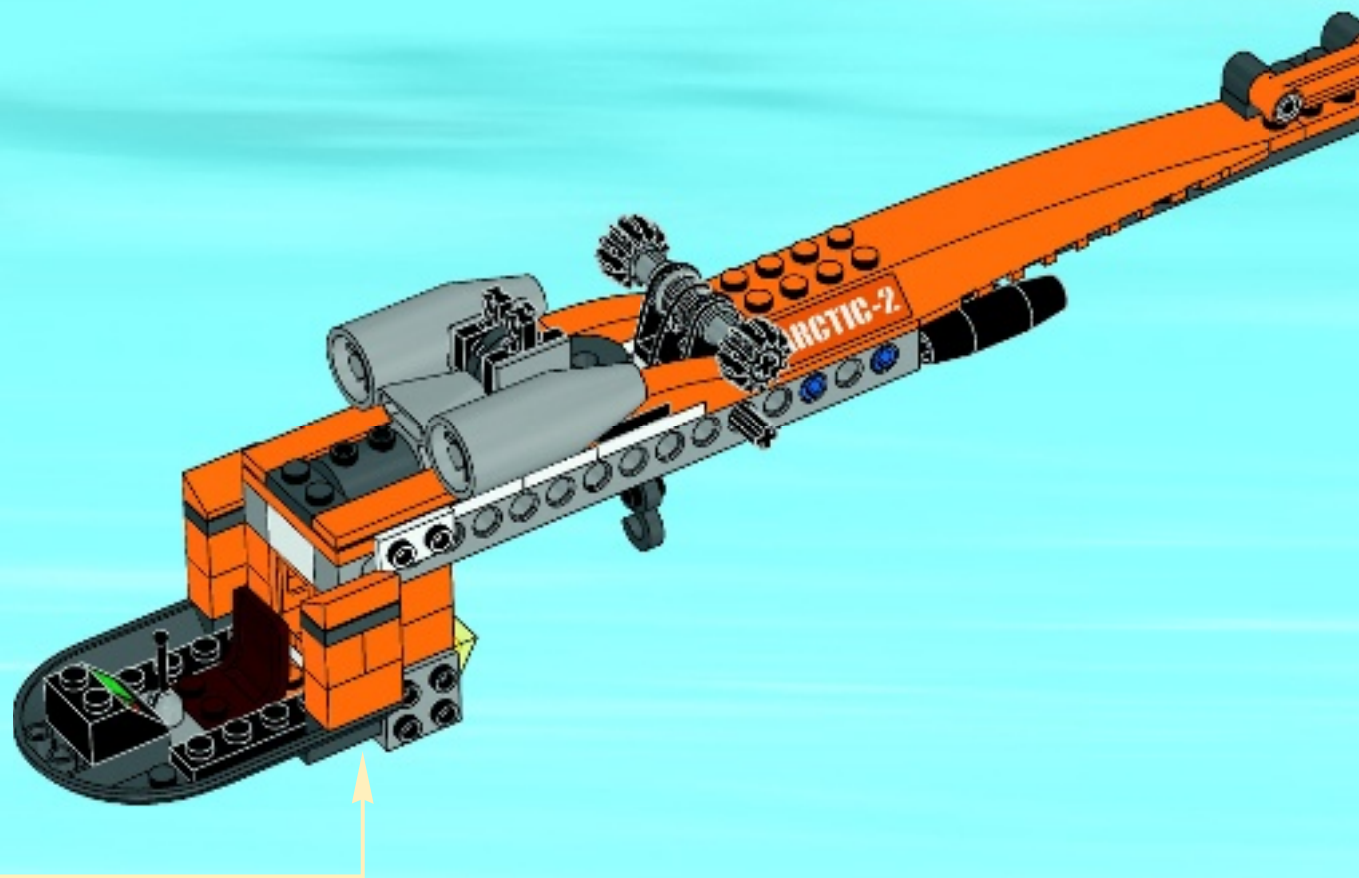

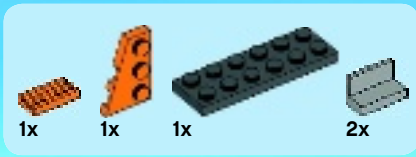

23

1



2

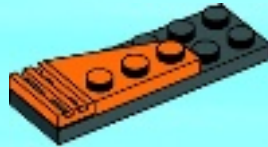

3

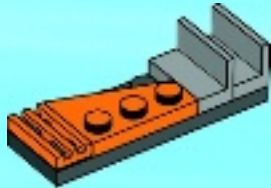

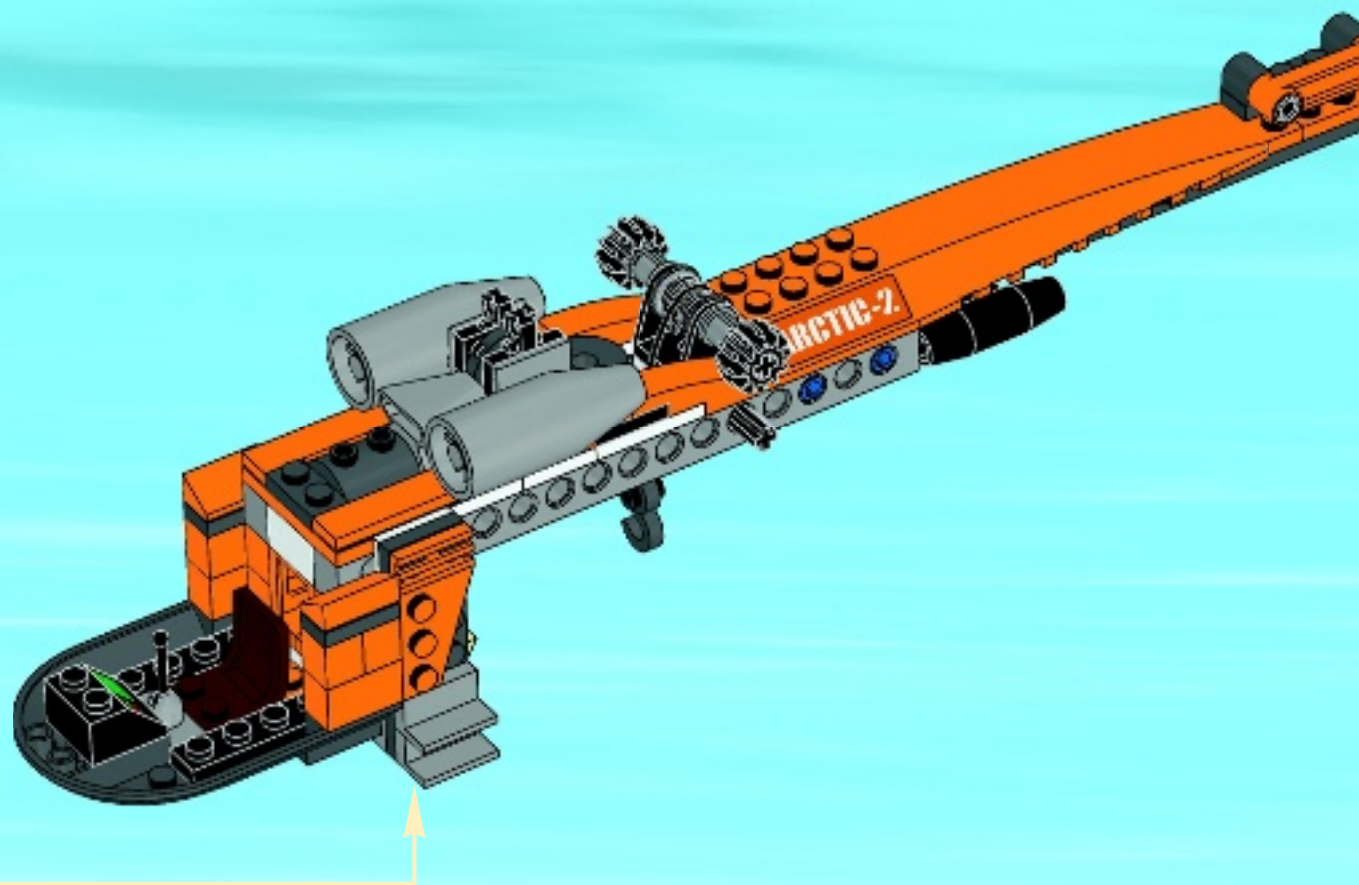

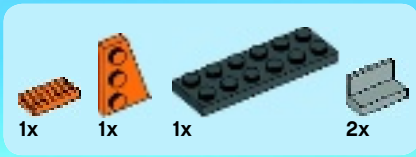

24

1



2



3

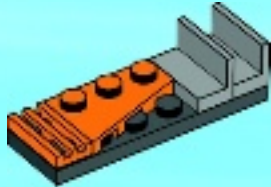

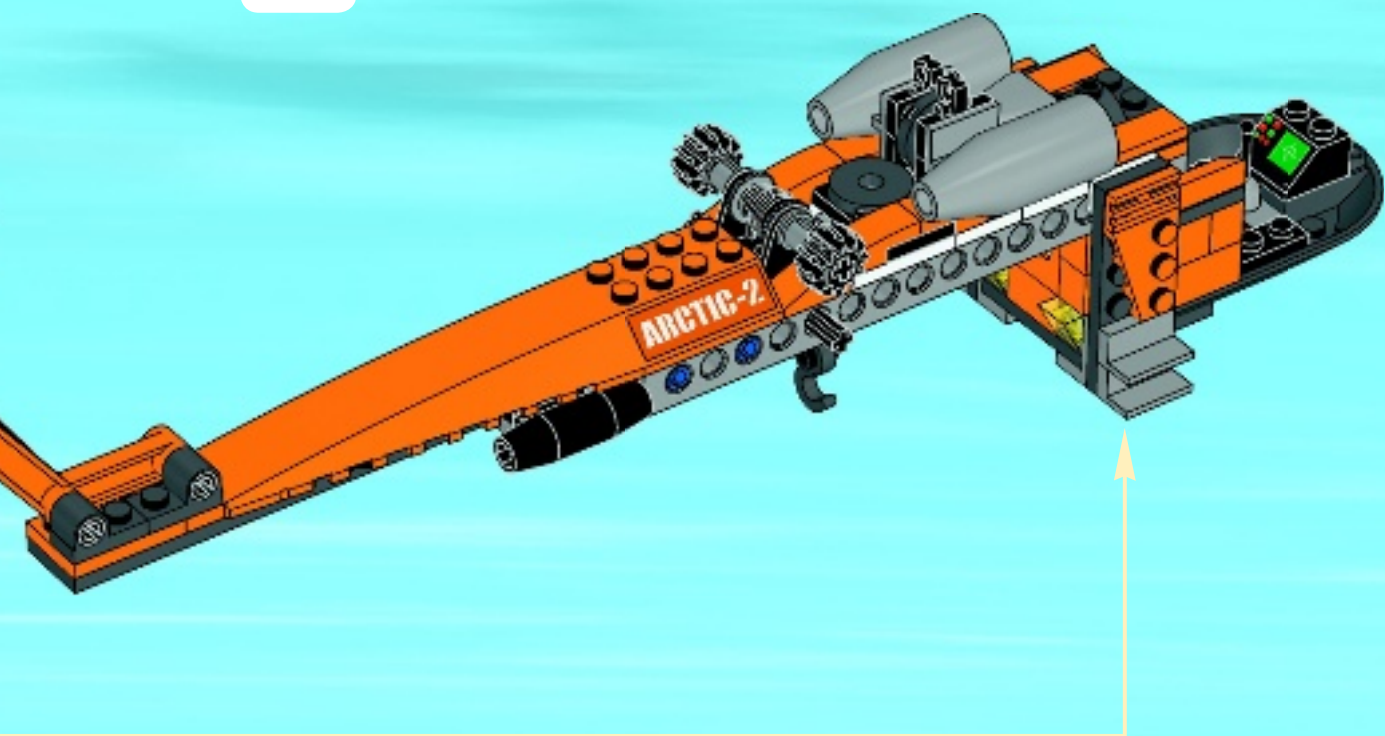

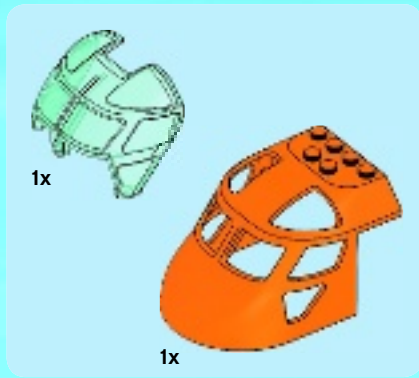

25

1

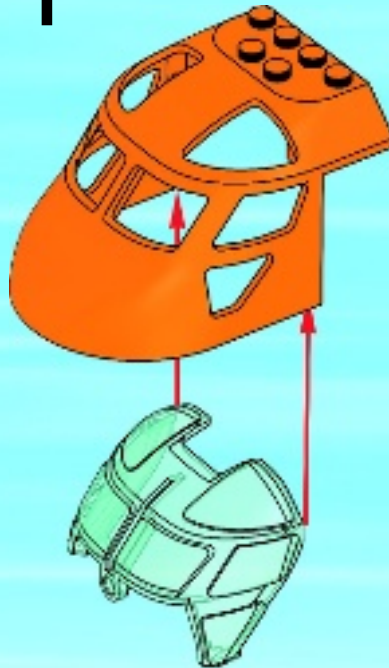

2

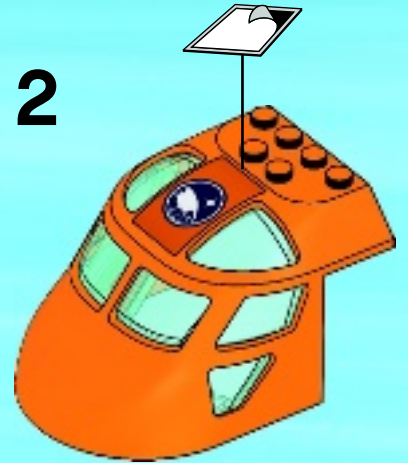

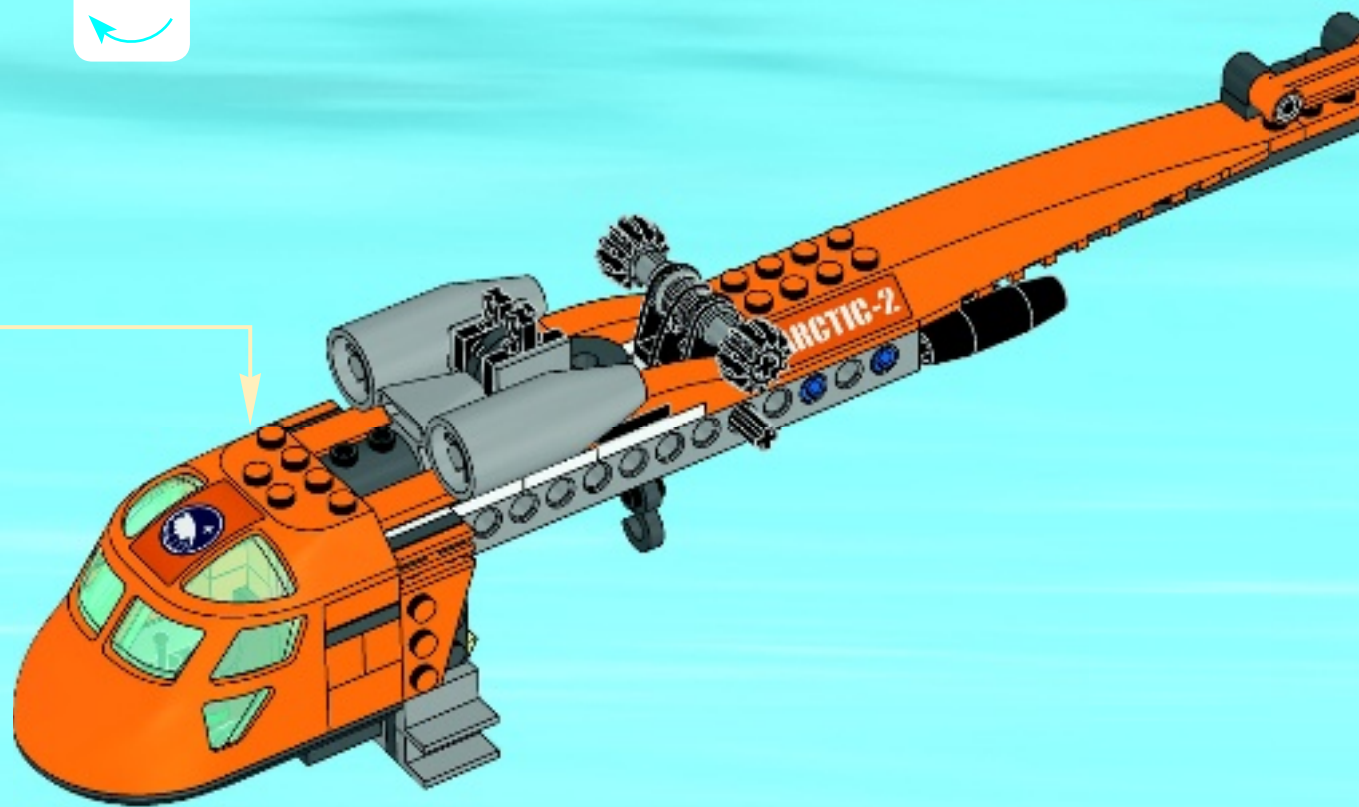



3x

26

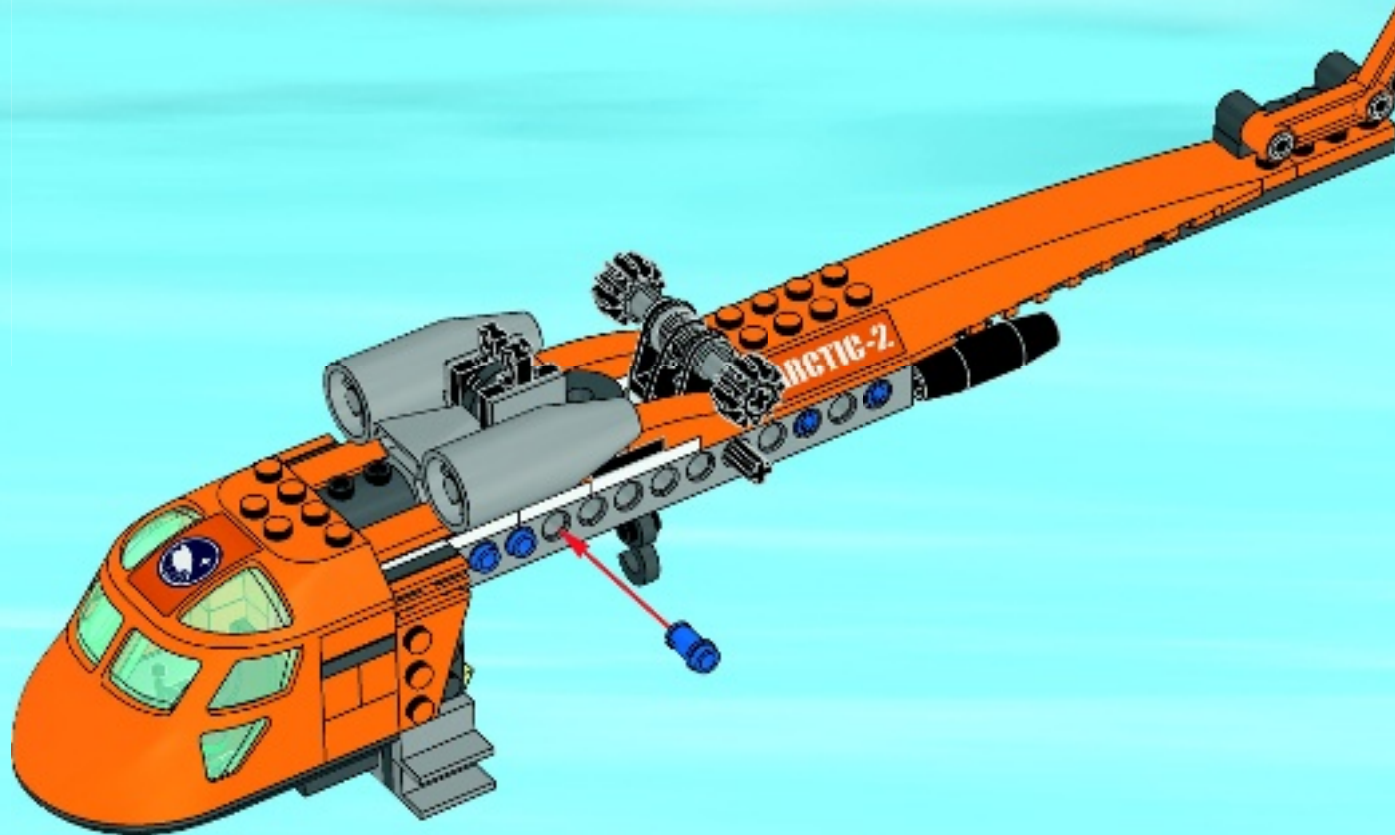



1x

27

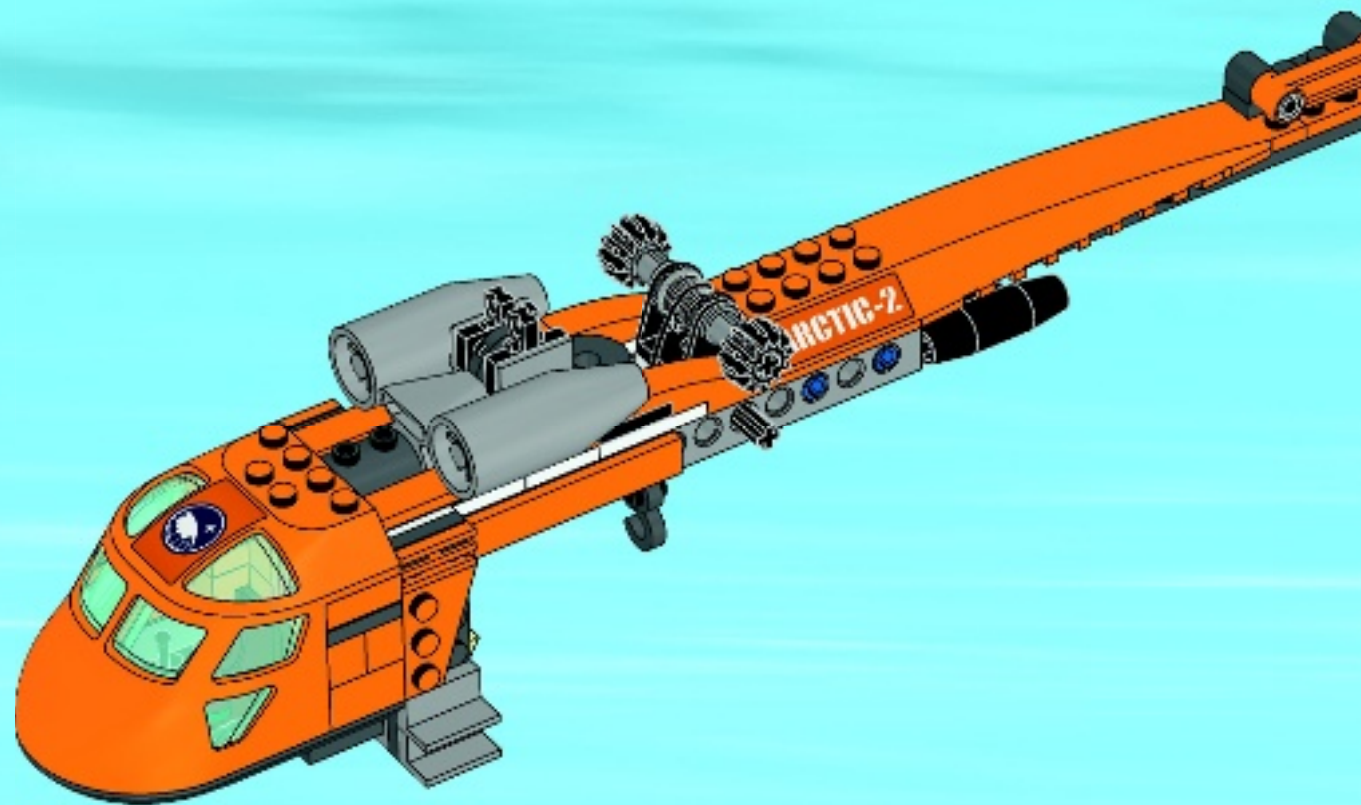



2x



2x

28

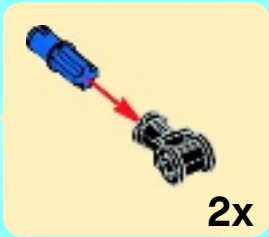
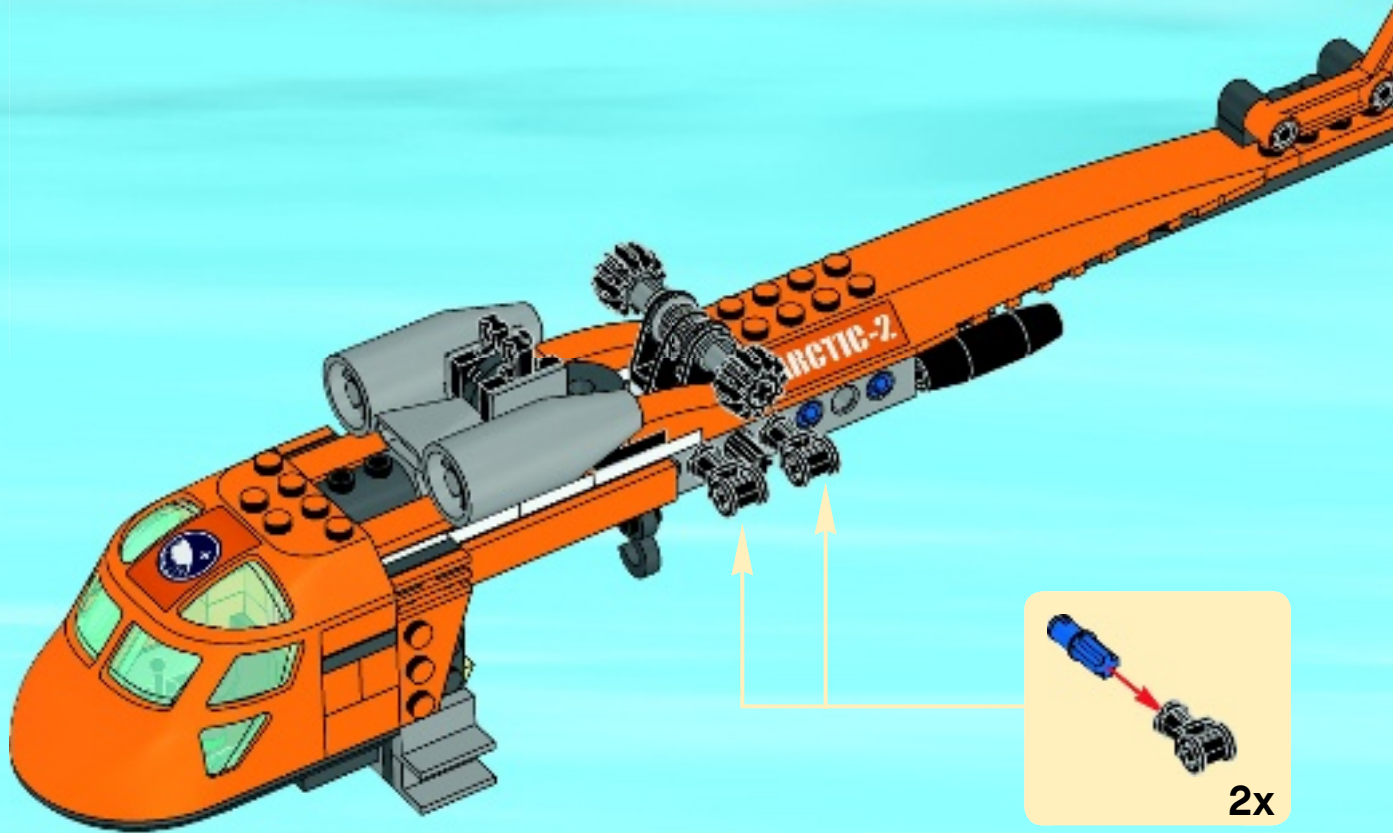

2x



1x

29

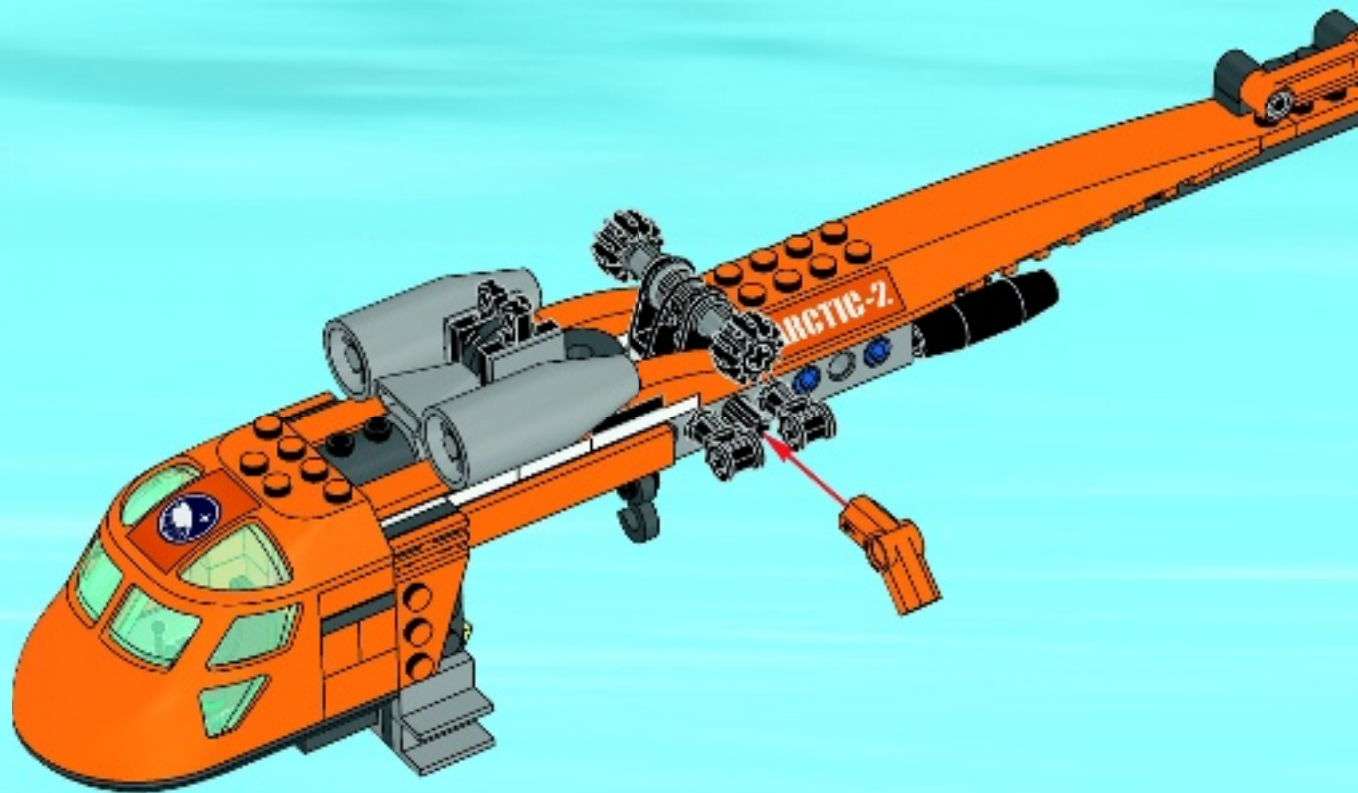

1x

1x

30

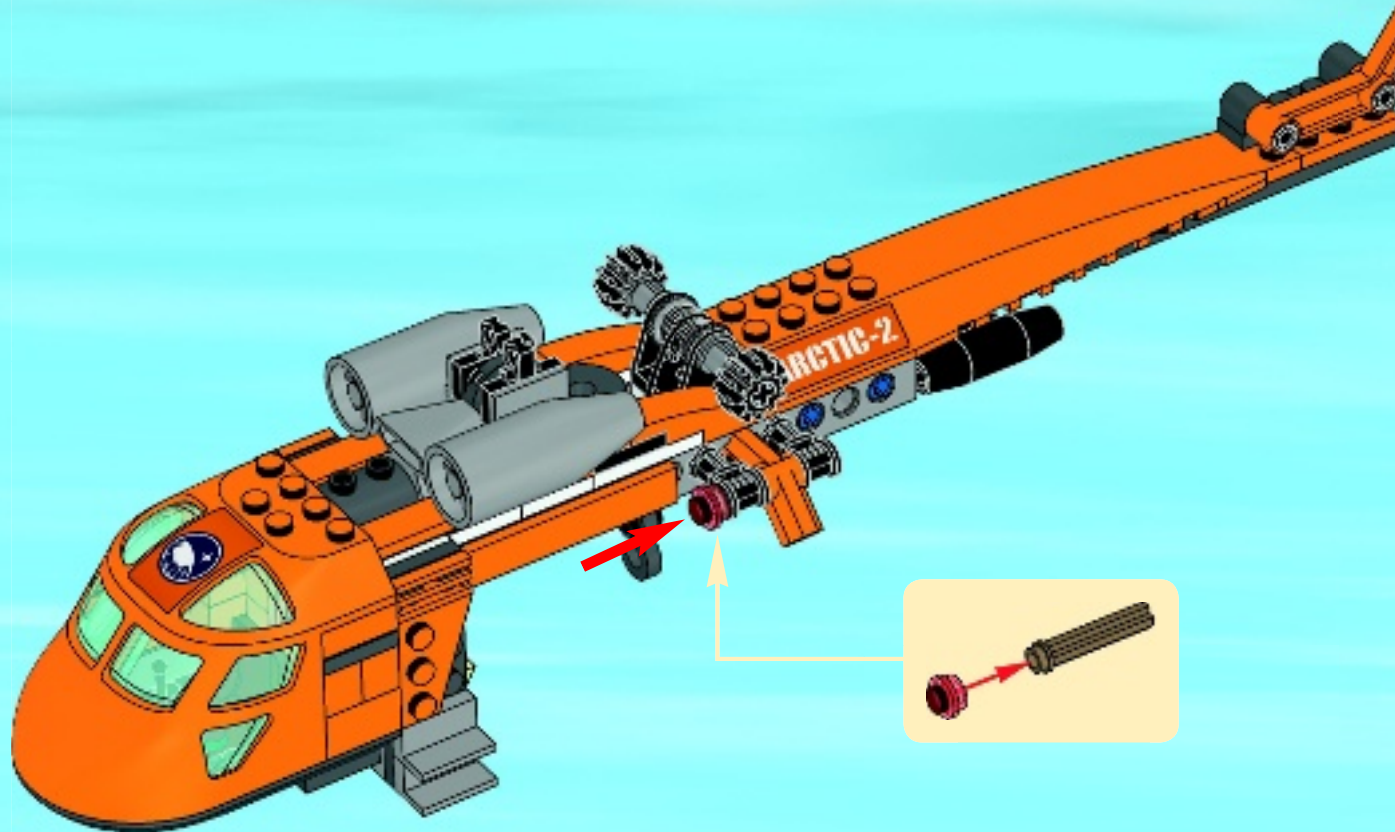



3x

31

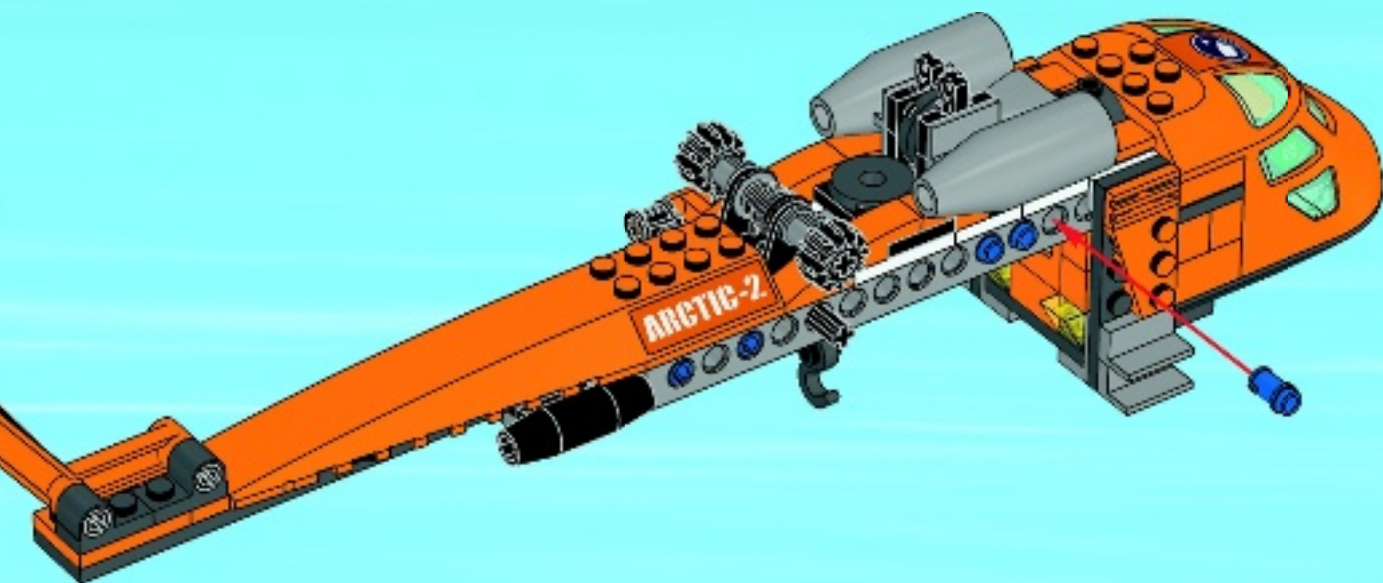



1x

32

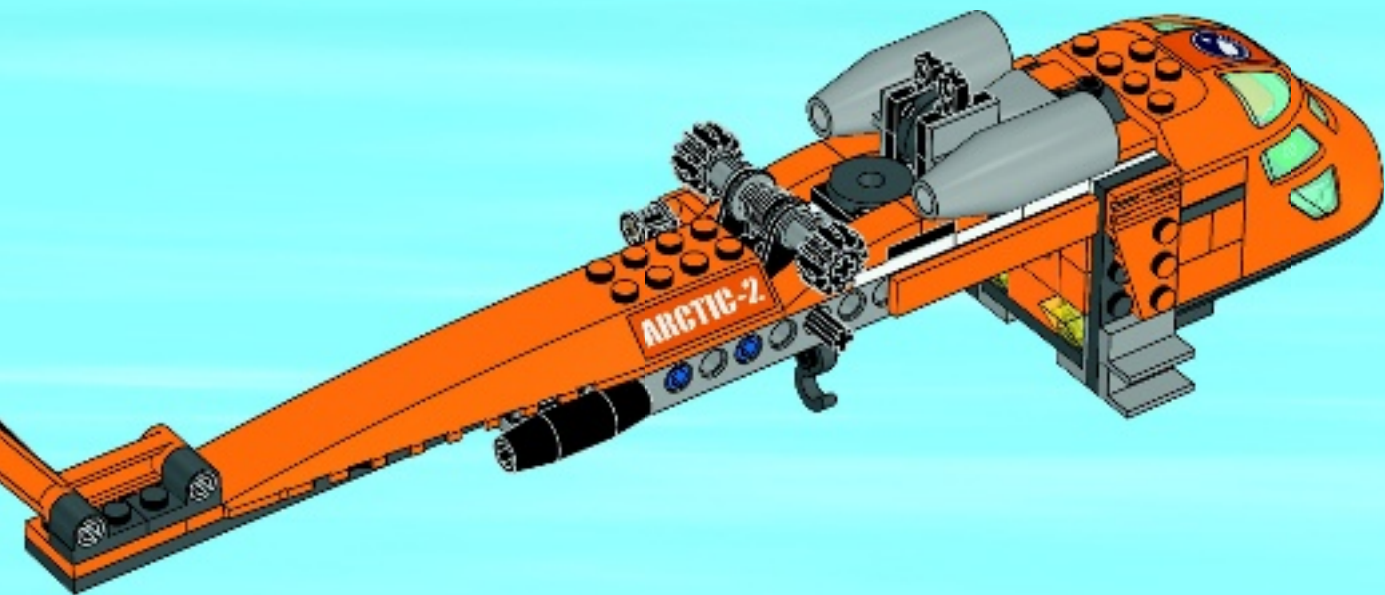



2x



2x

33

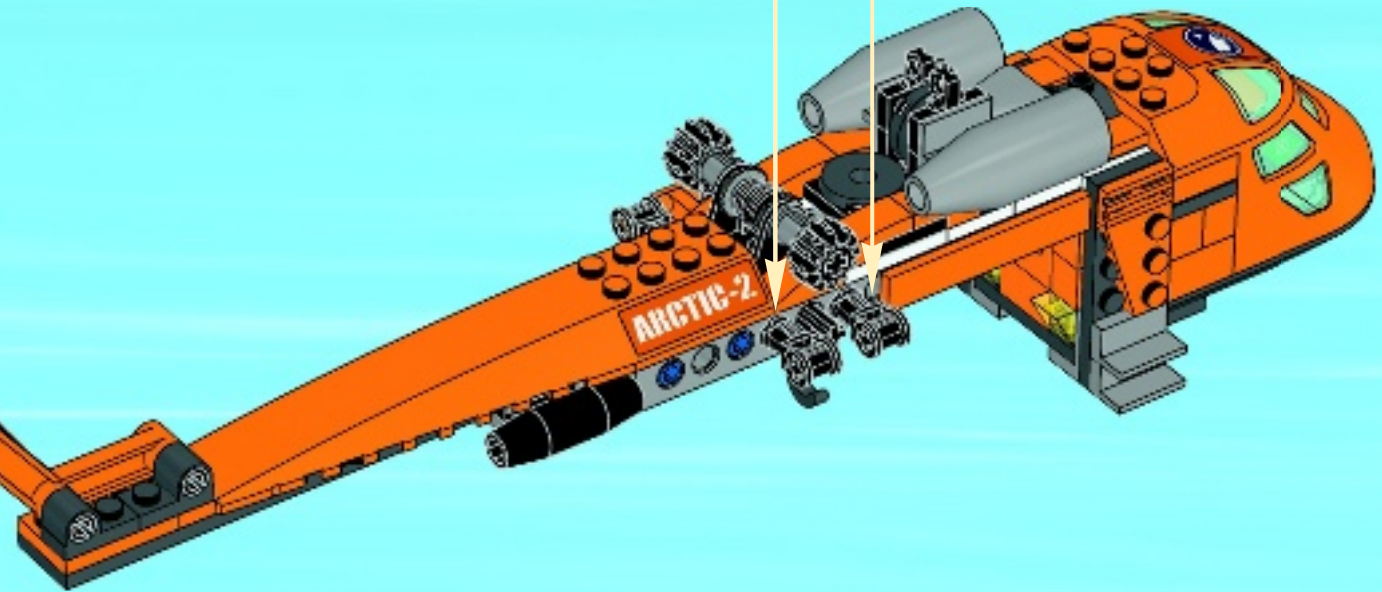
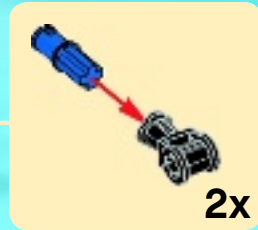



1x

34

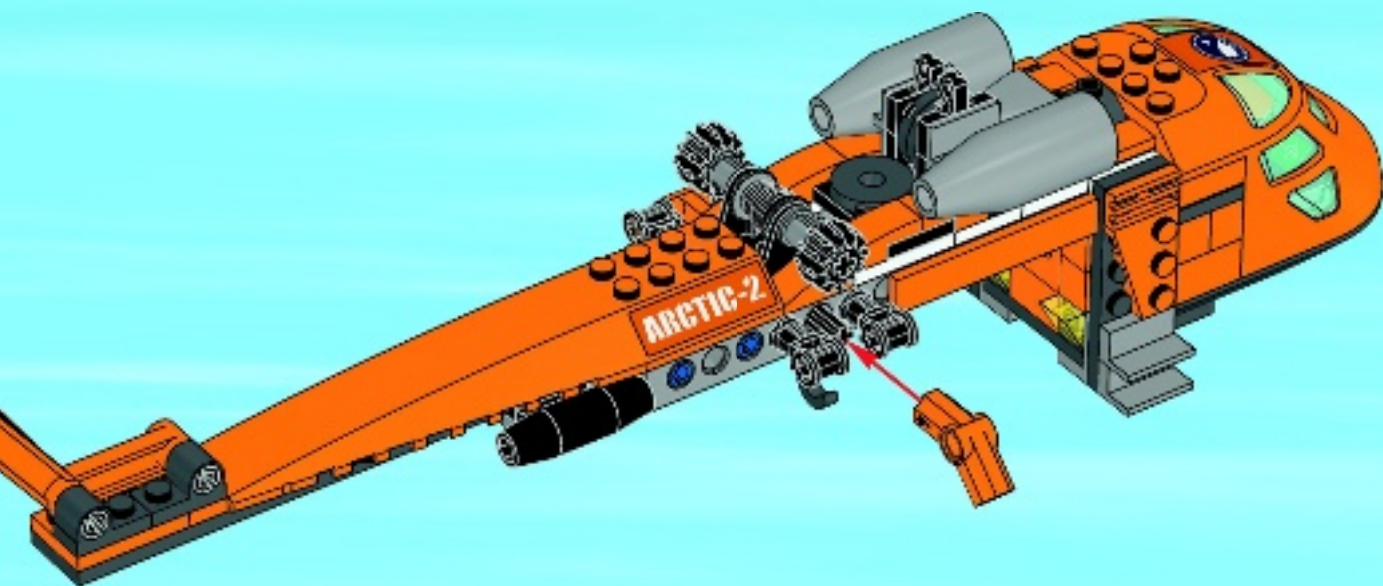



1x



1x

35

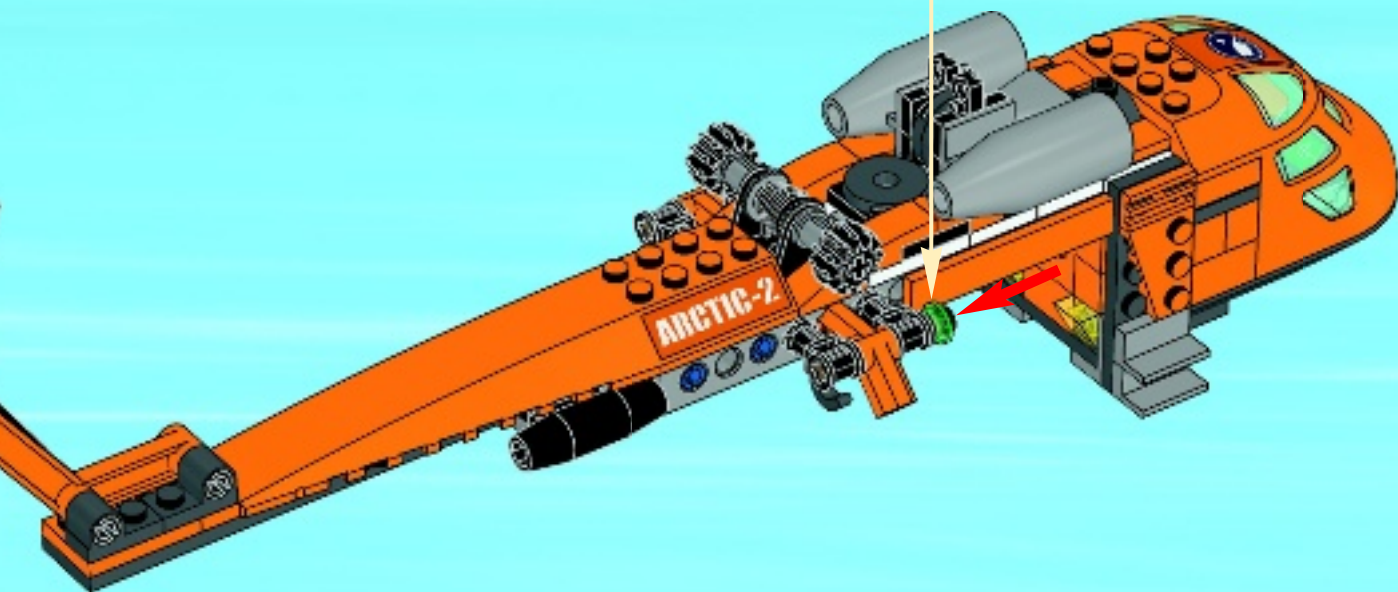
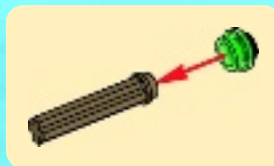



2x



2x



6x

36

1



2

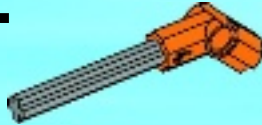

3

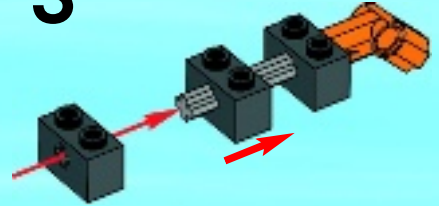

2x

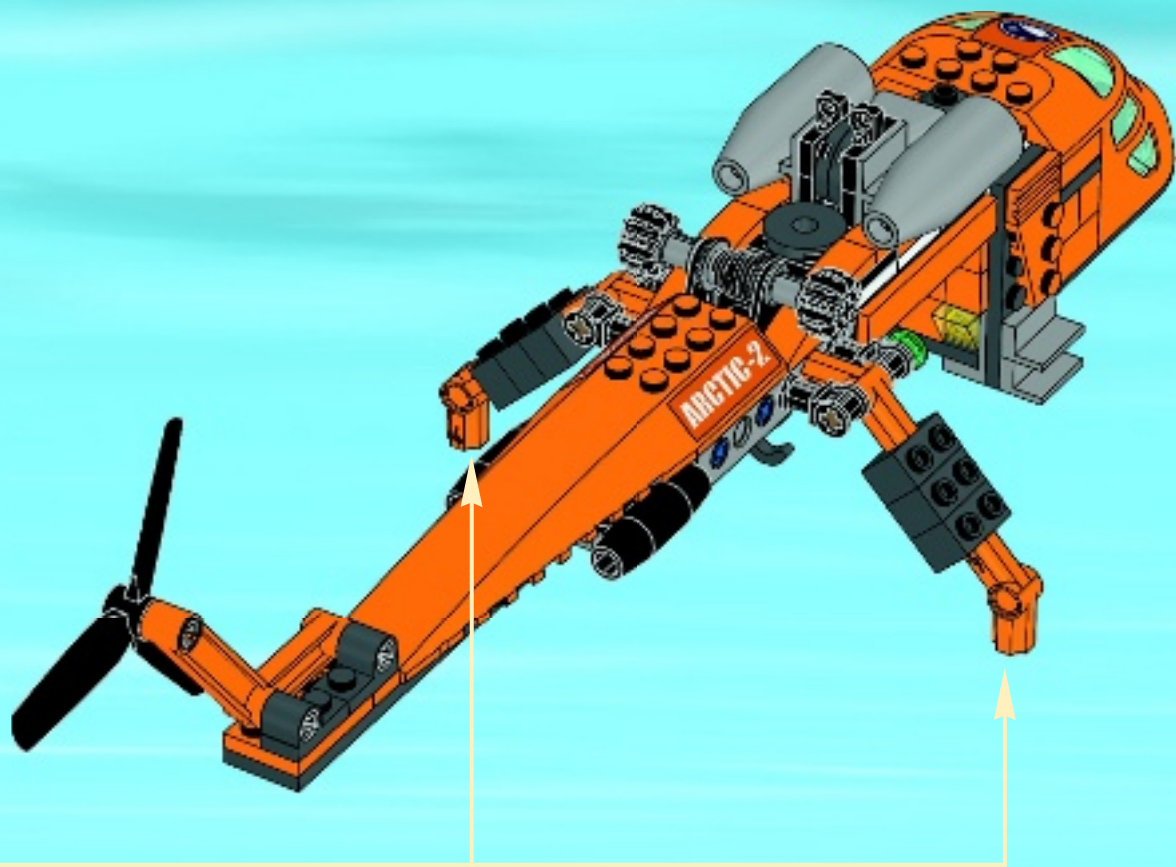



2x



2x



2x

37



1



2

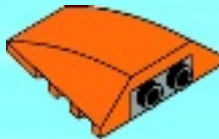

3



4



2x

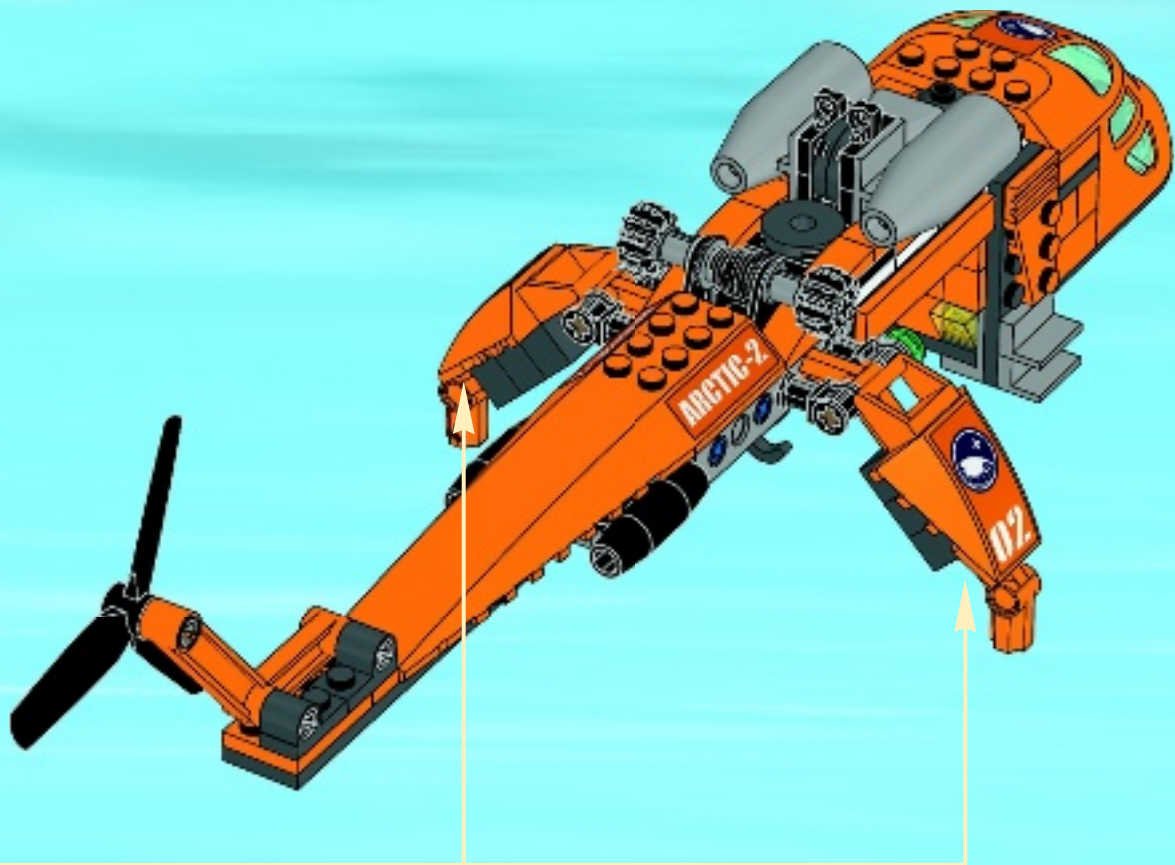

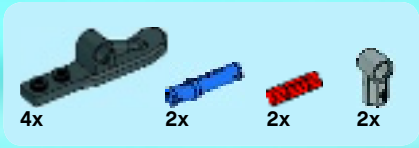

38

1



2

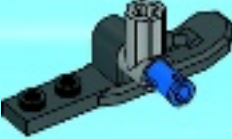

3

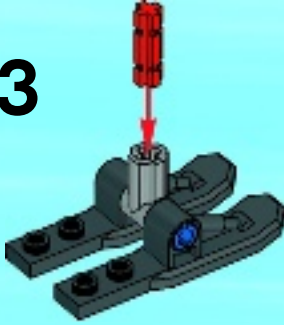

2x

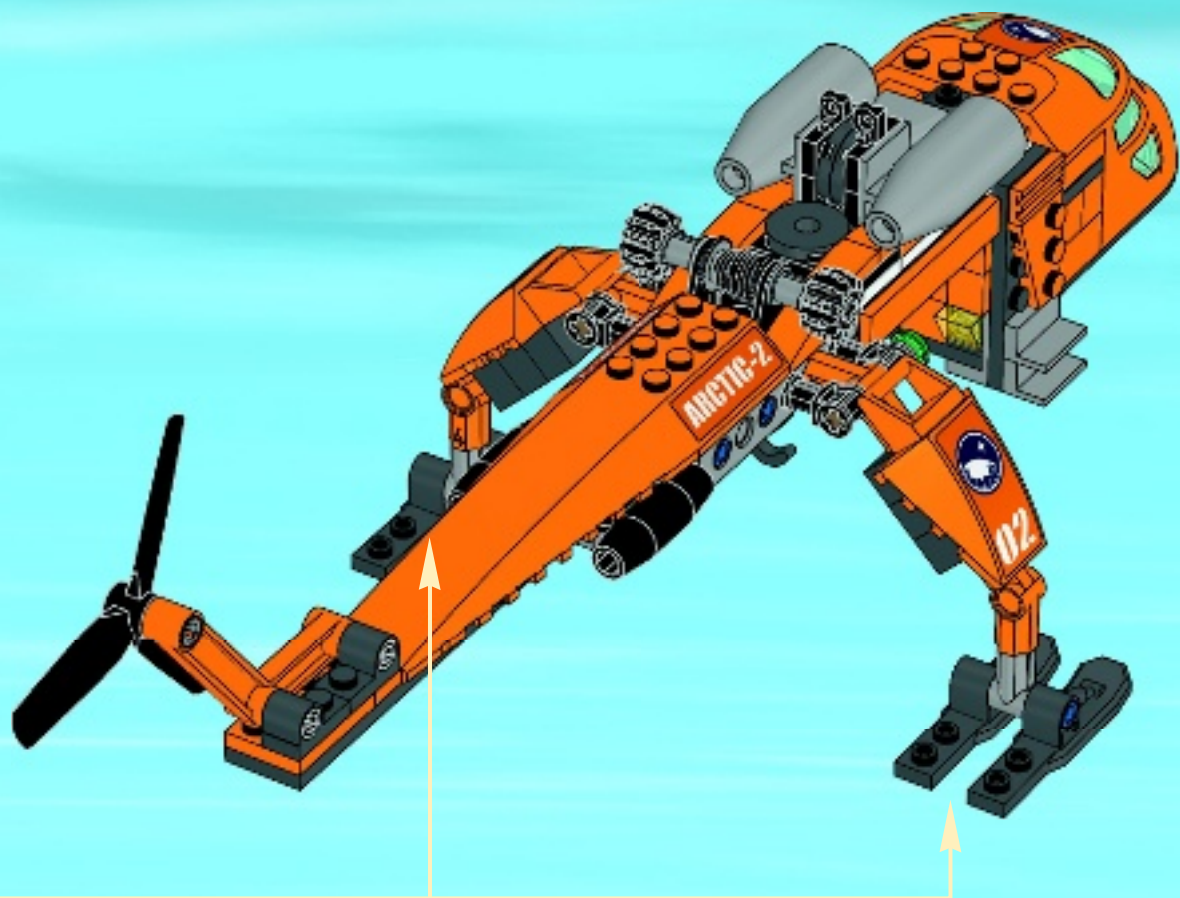



39

1

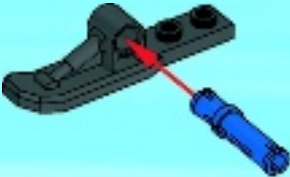

2

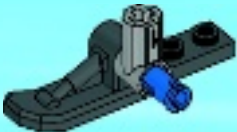

3

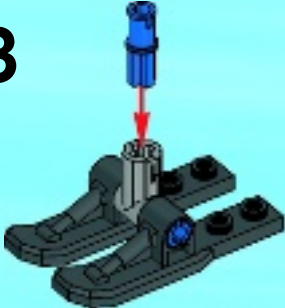

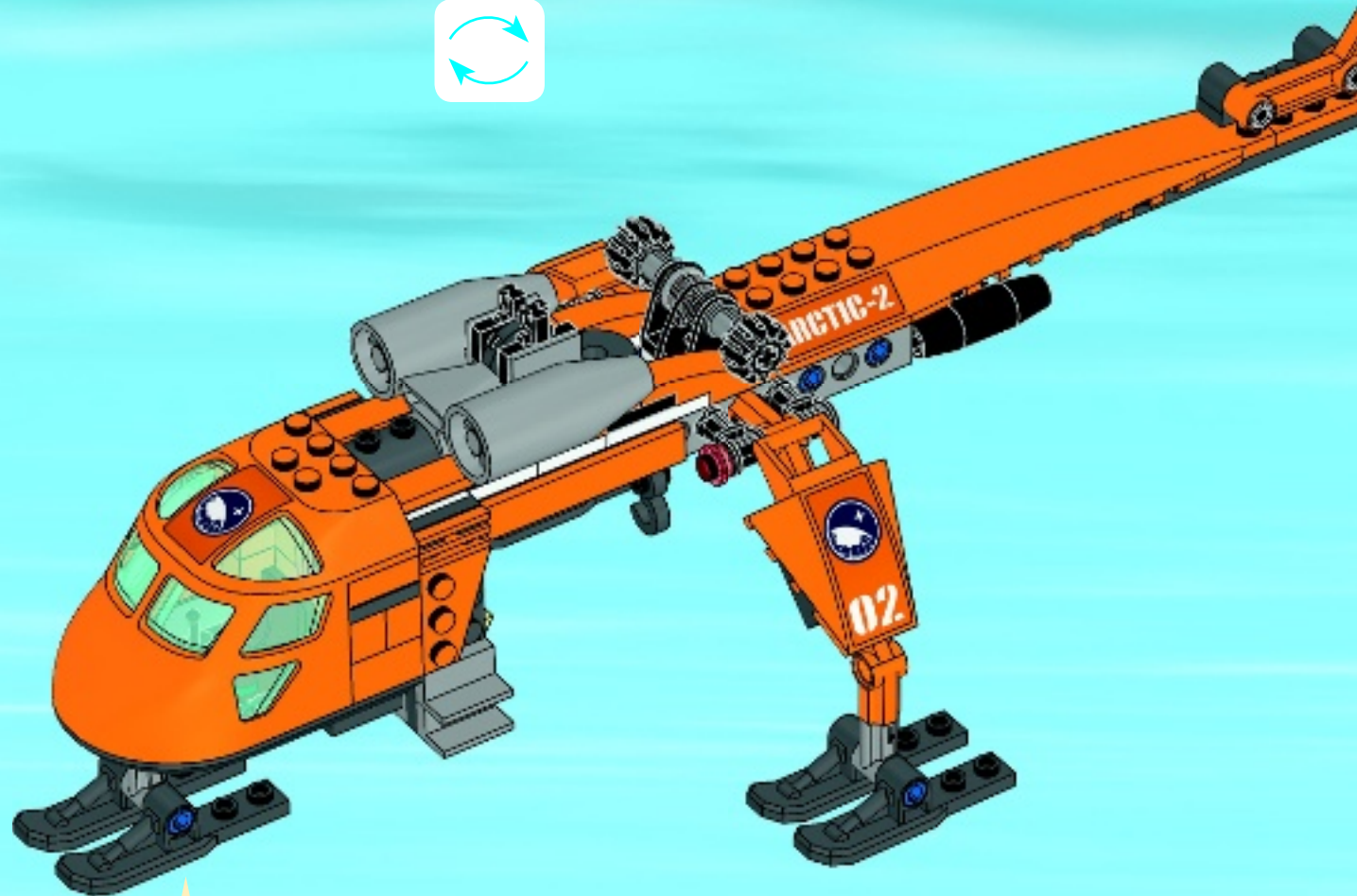



1x



1x



1x

1



2



40

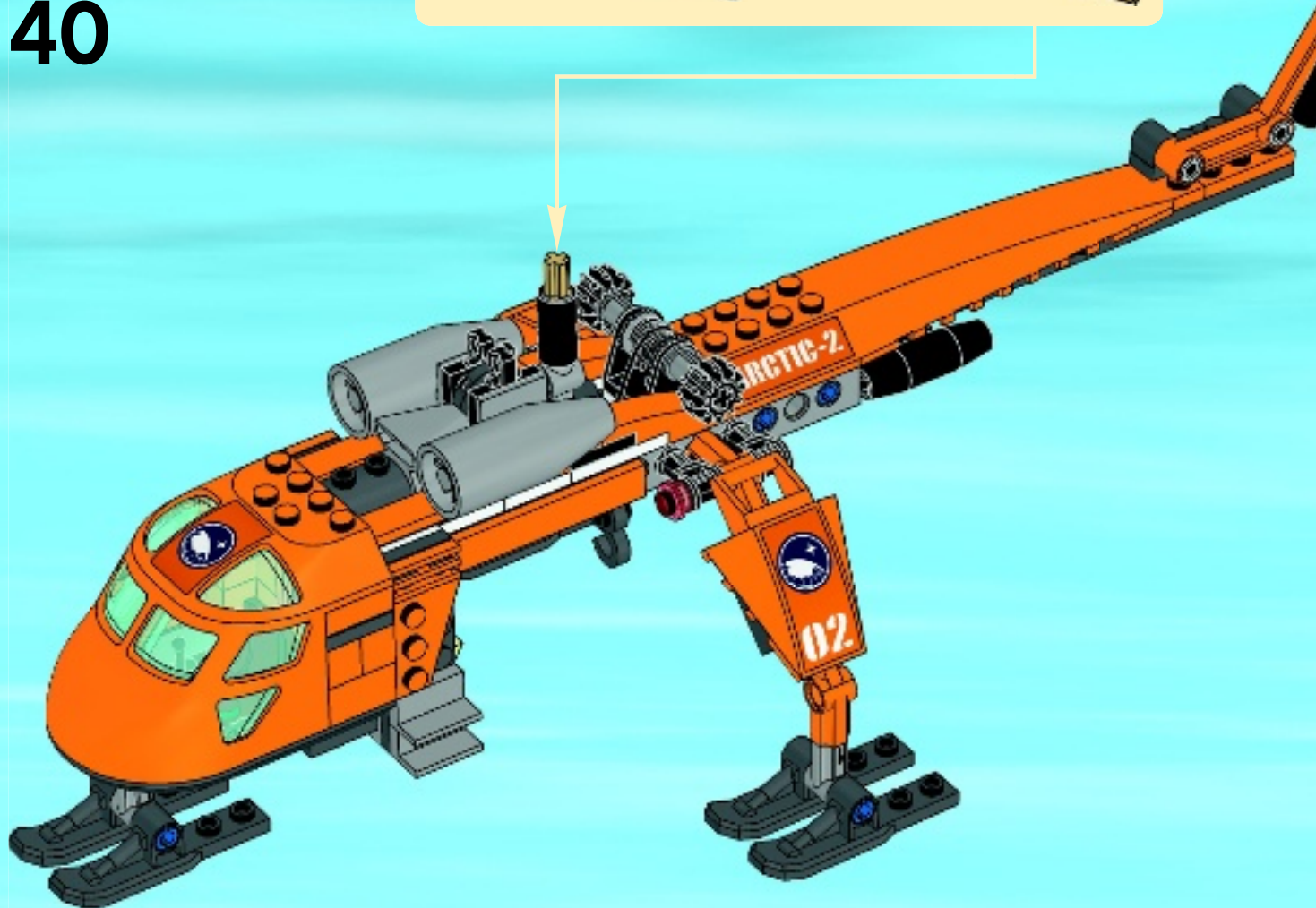

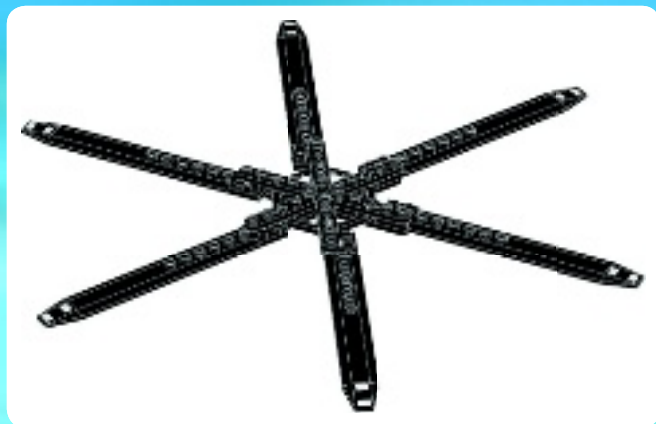

1x

1



6x

2





3

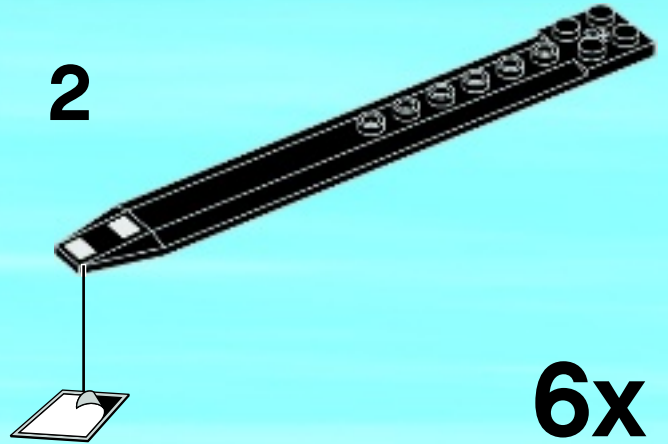

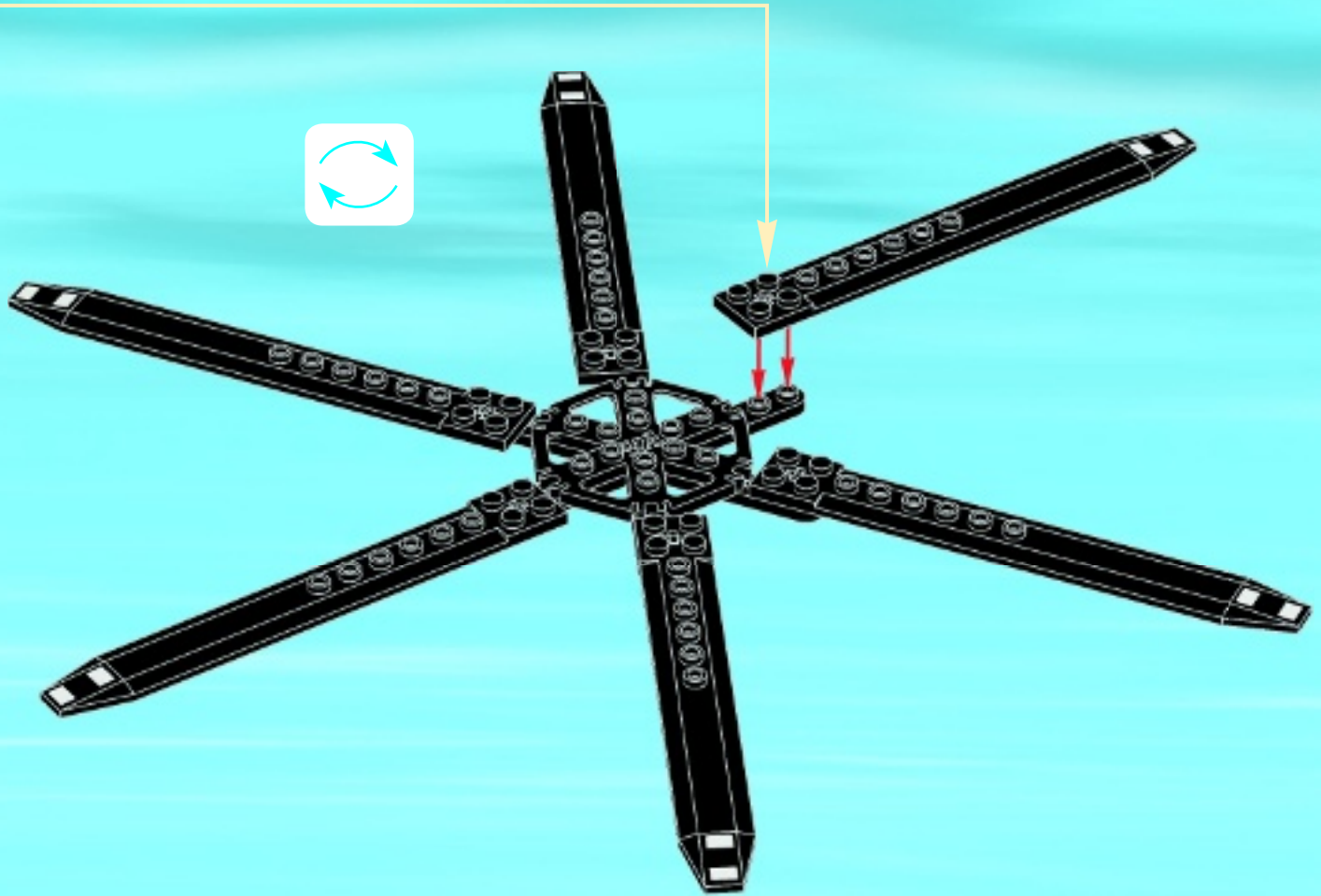



6x

4

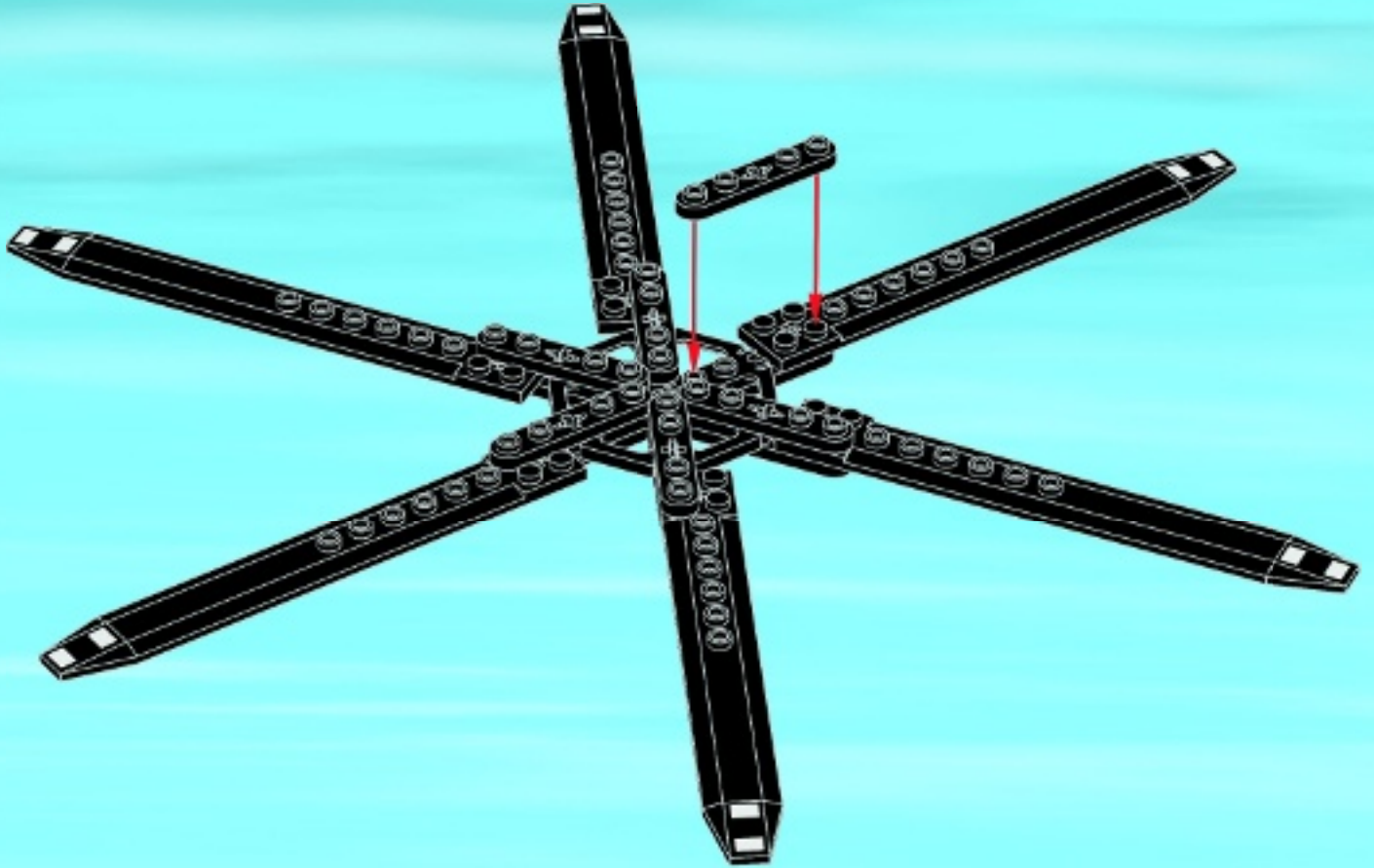

41





1x

42





LEGO CITY

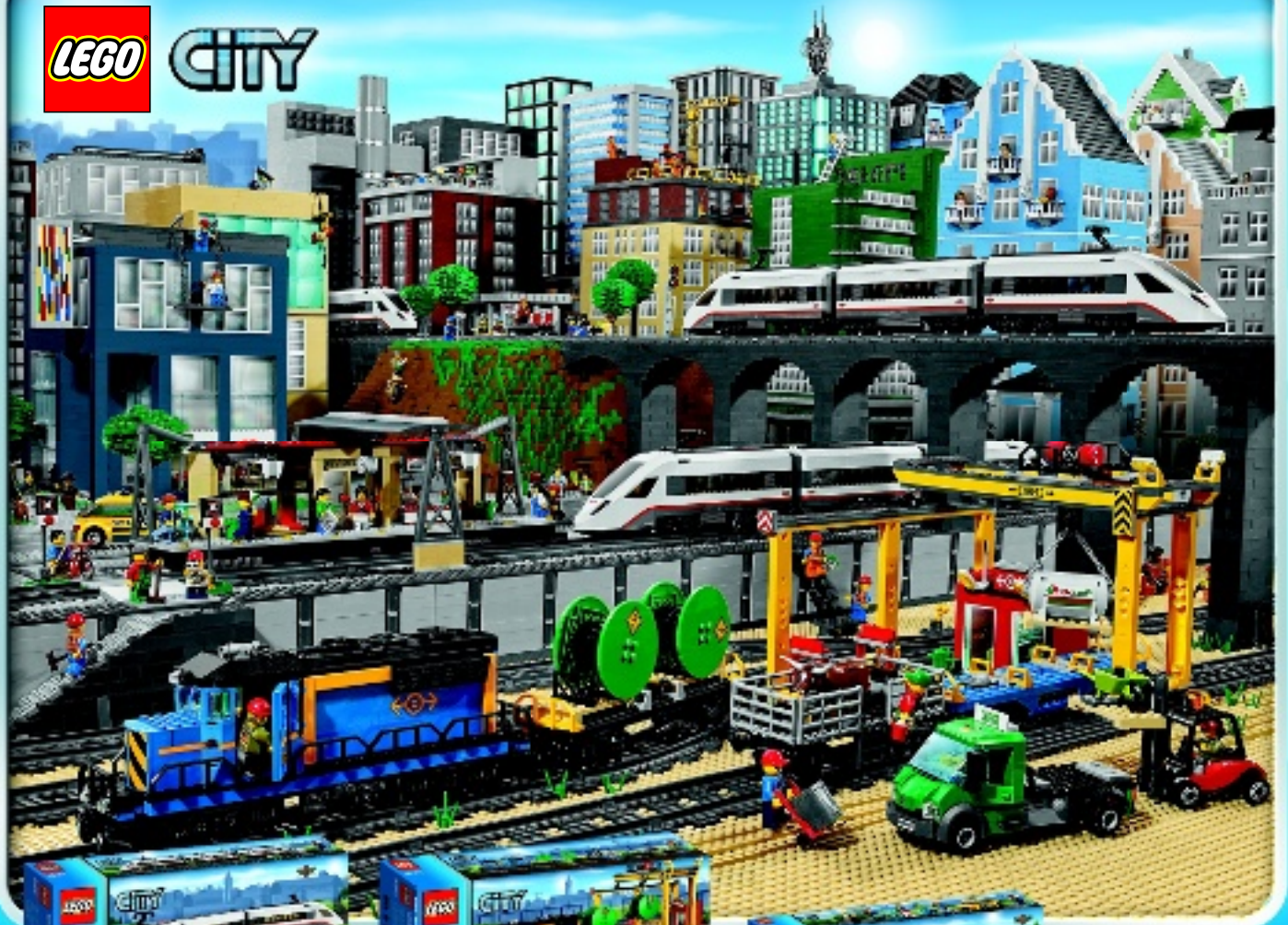

60051



60052



60050

LEGO.COM/CITY



CITY

MY CITY

NEW! FREE ONLINE GAME & APP!
NOUVEAU ! JEU EN LIGNE ET APPLI GRATUITS !
NOVEDAD! ¡JUEGO ONLINE Y APP GRATIS!



LEGO.COM/CITY
ANDROID APP ON
 Google play
Available on the
 App Store

LEGO.COM/CITY

SECRET CODE:
MYCITYBONUS
USE THE CODE FOR BONUS STUDS
IN THE ONLINE GAME
(EXPIRES 12/31/2015)

CODE SECRET :
MYCITYBONUS
UTILISE LE CODE POUR OBTENIR DES
TENONS BONIS DANS LE JEU EN LIGNE
(EXPIRE LE 31/12/2015)

CÓDIGO SECRETO:
MYCITYBONUS
USA EL CÓDIGO SECRETO PARA OBTENER
PUNTOS EXTRA EN EL JUEGO ONLINE
(HASTA EL 31/12/2015)

Apple, the Apple logo, iPad, iPhone and iPod touch are trademarks of Apple Inc., registered in the U.S. and other countries.
App Store is a service mark of Apple Inc.
Apple, le logo Apple, iPad, iPhone et iPod touch sont des marques de commerce d'Apple Inc., déposées aux États-Unis et dans d'autres pays.
App Store est une marque de service d'Apple Inc.
Apple, el logotipo de Apple, iPad, iPhone e iPod touch son marcas comerciales de Apple Inc., registradas en EE. UU. y otros países.
App Store es una marca de servicio de Apple Inc.

Google Play is a trademark of Google Inc.
Google Play est une marque de commerce de Google Inc.
Google Play es una marca comercial de Google Inc.

LEGO and the LEGO logo are trademarks of the/son des marques de commerce de/son marcas registradas de LEGO Group.
©2014 The LEGO Group. 6092605